

Kingdoms

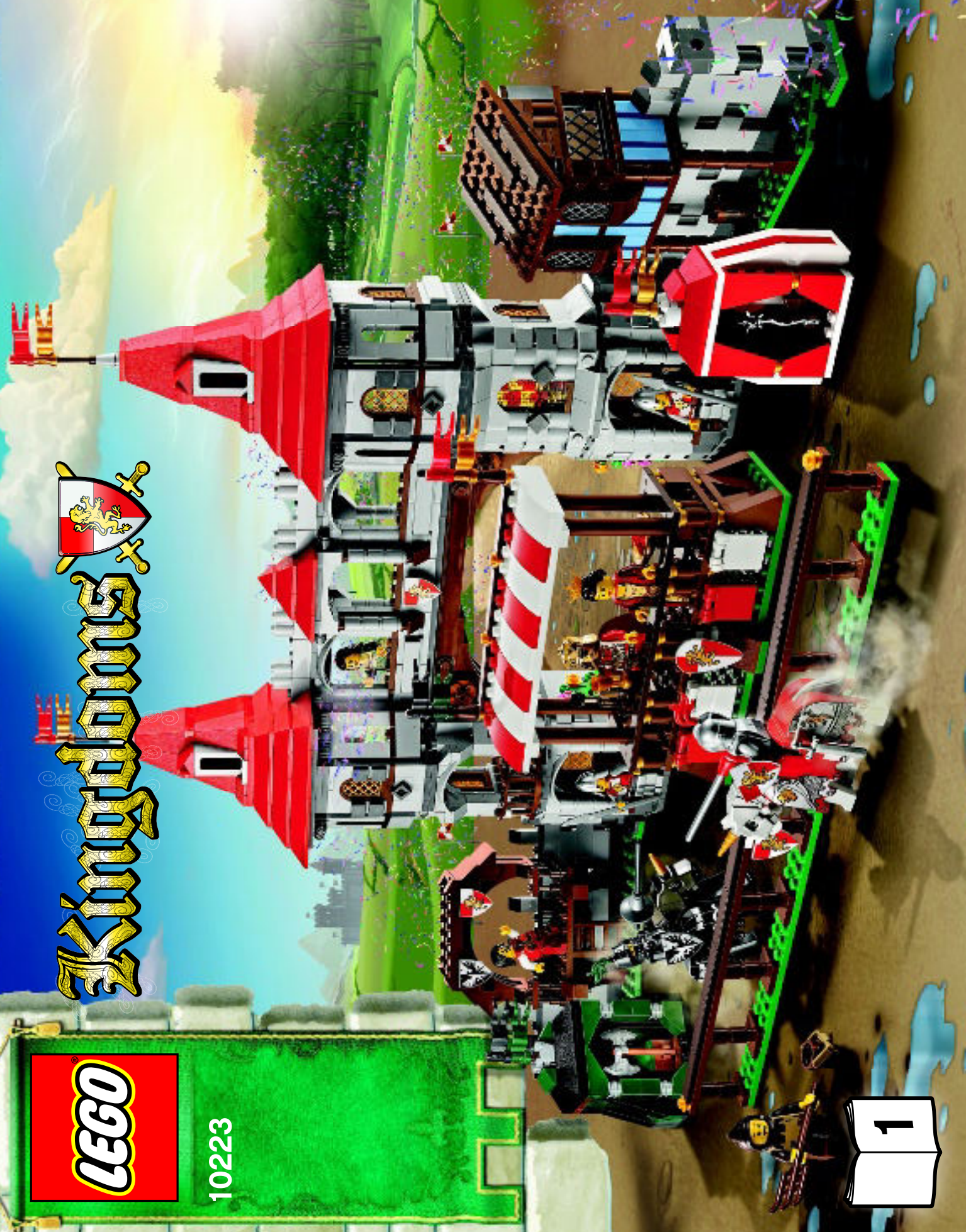

10223

LEGO



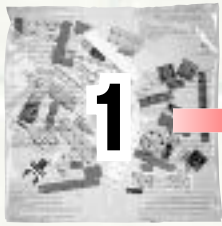

1

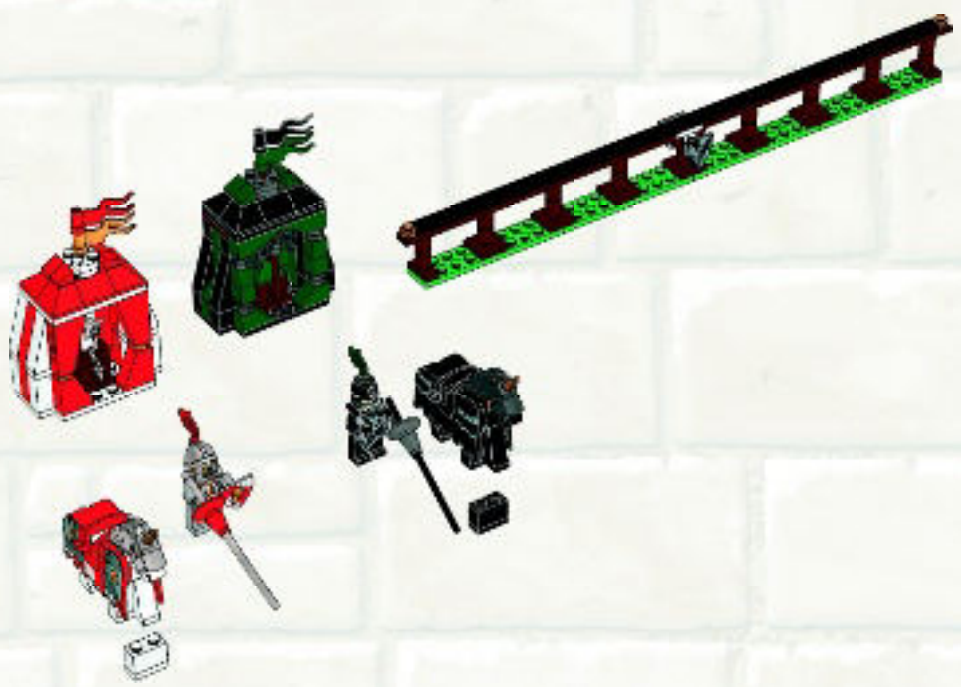

2



3



4



5



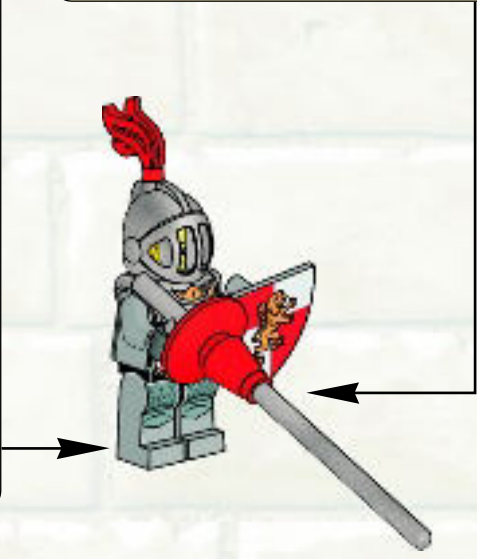
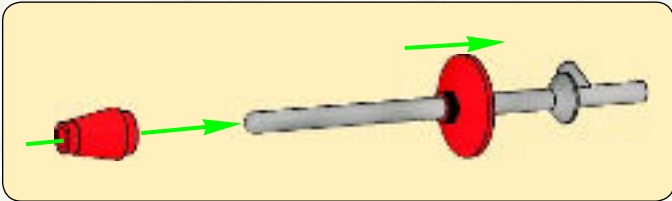
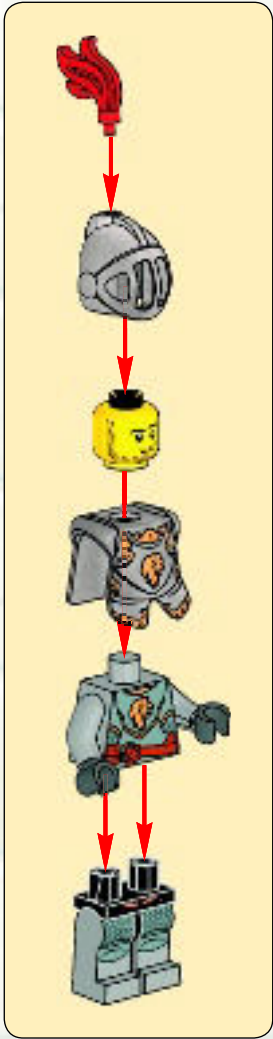
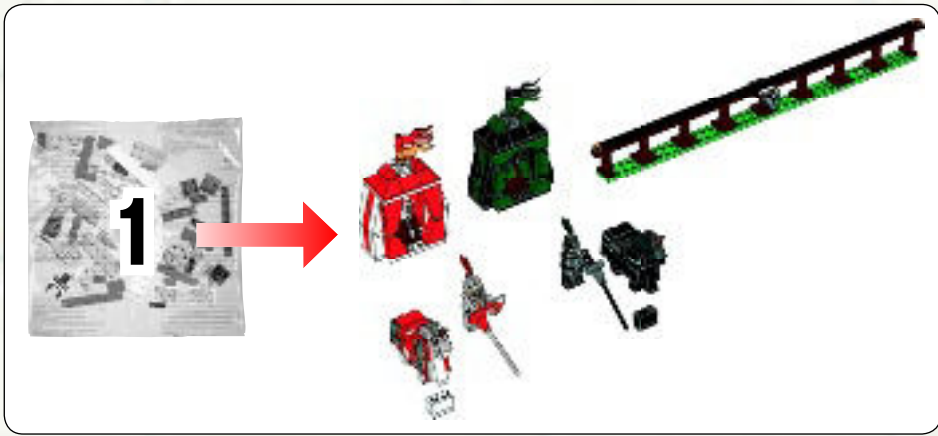

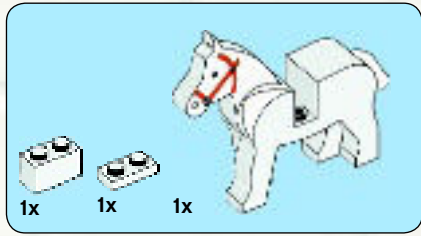

1

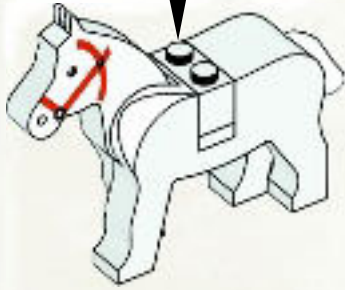
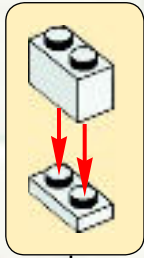

2

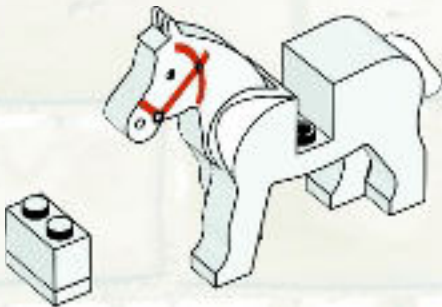

4

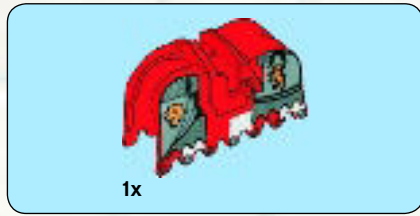

3

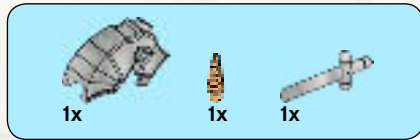
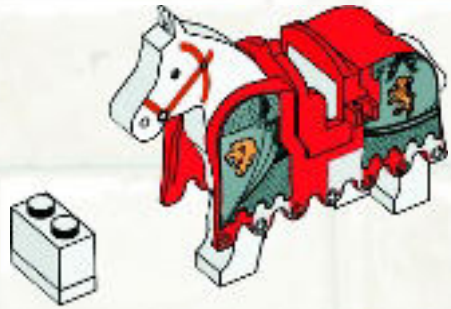

4

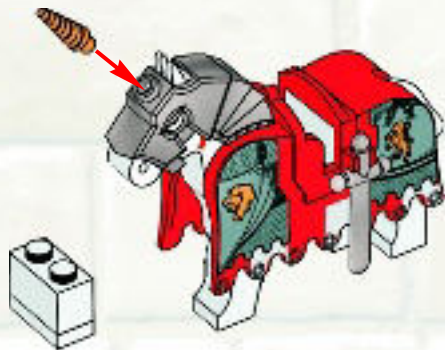

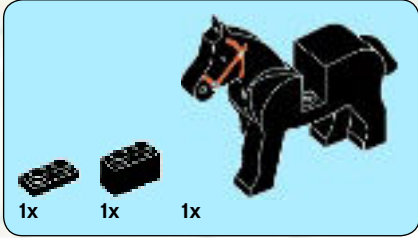

1

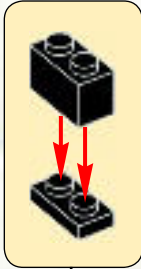

2



3



4



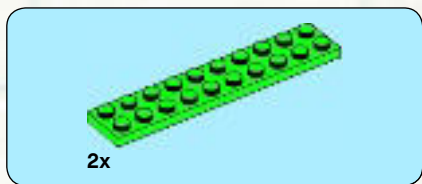
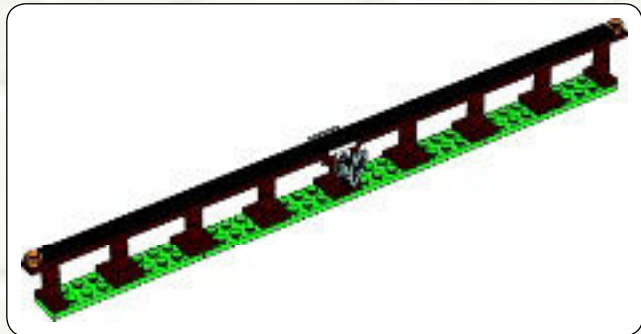

1

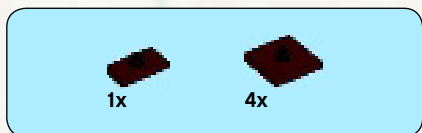
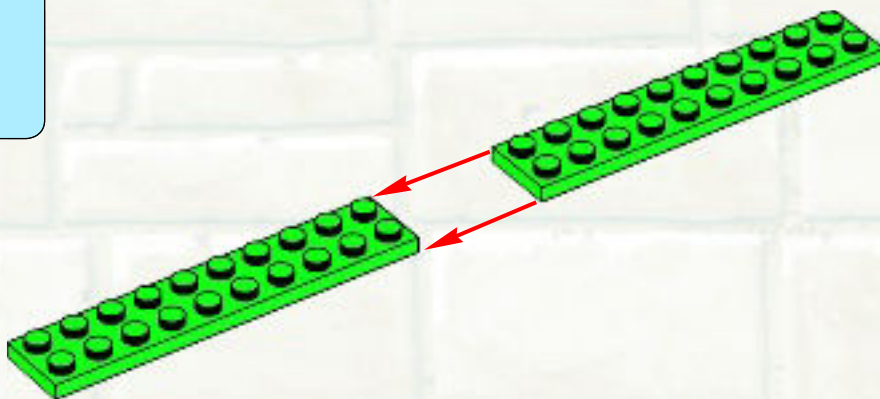

2

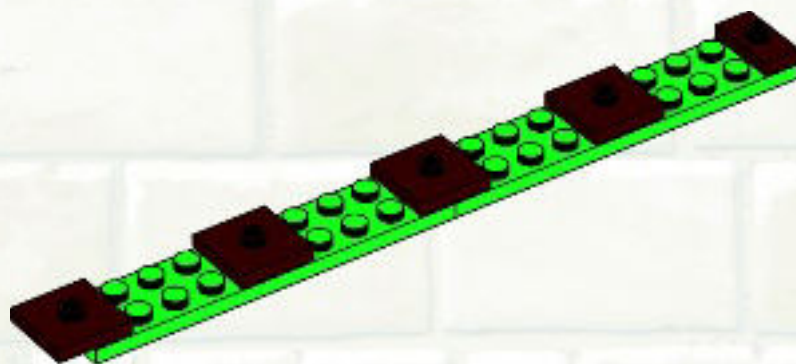

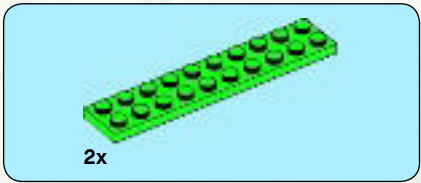

3

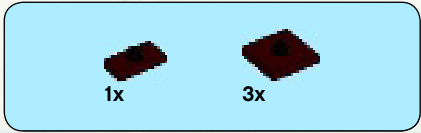
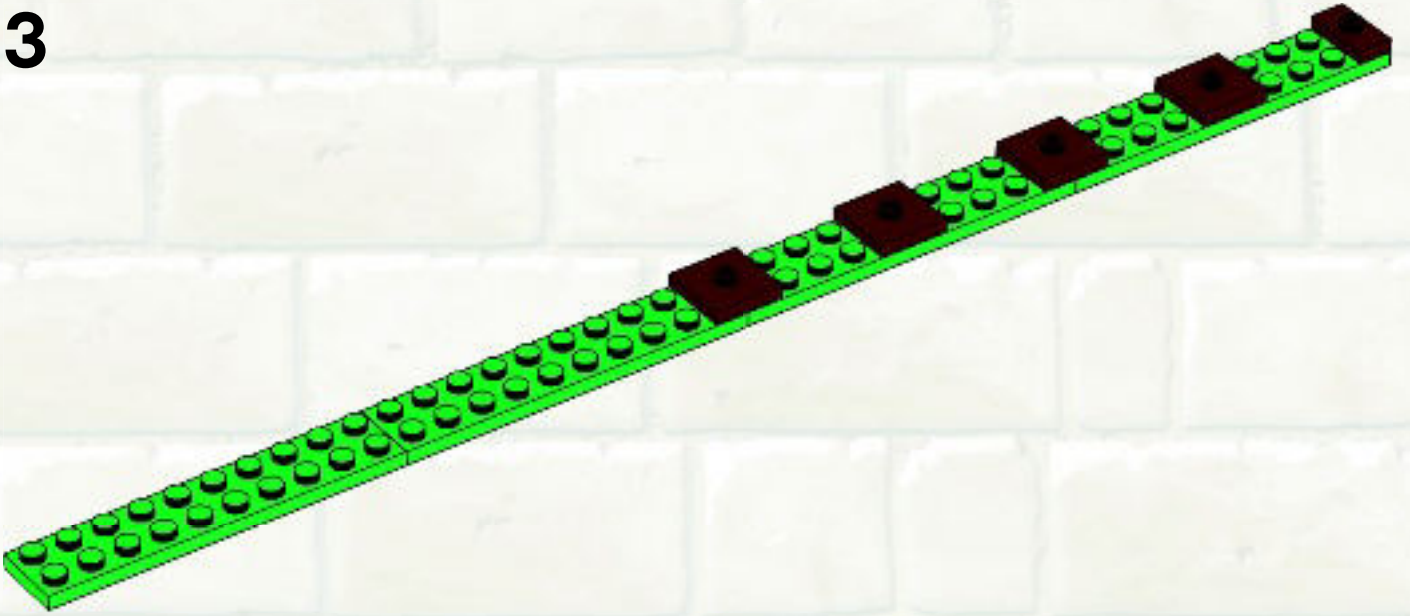

4

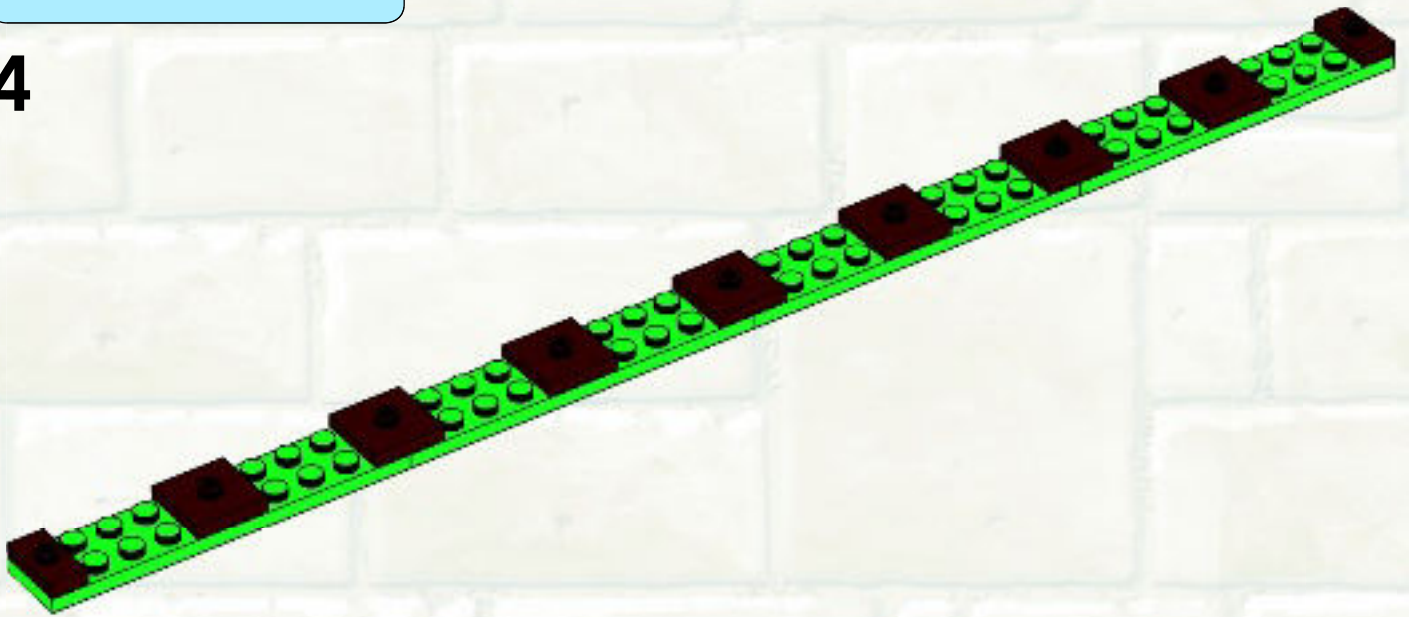



17x

5

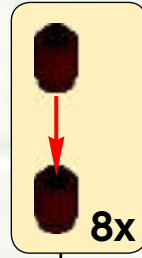

8x

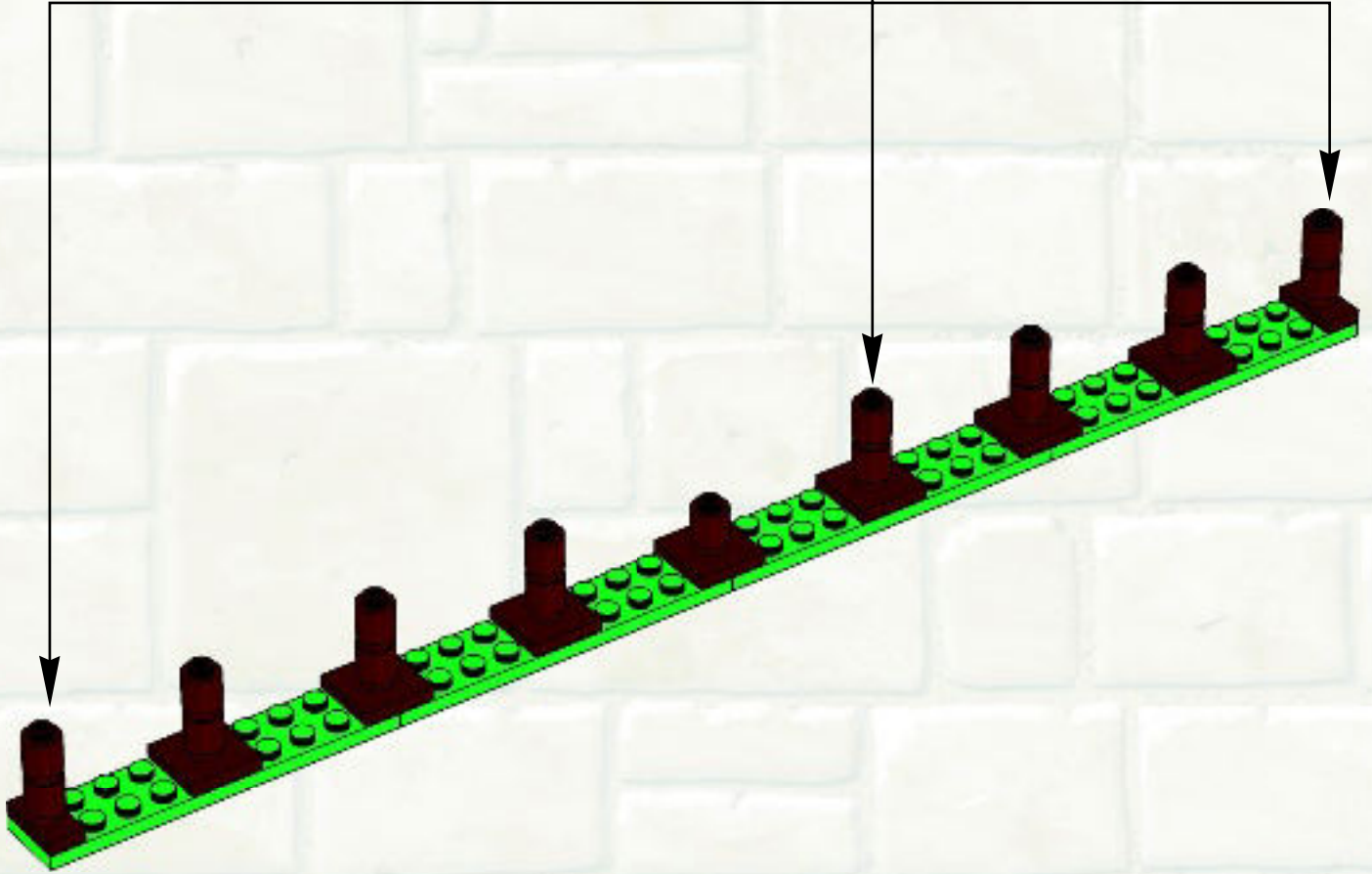



1x



2x

6

1



2

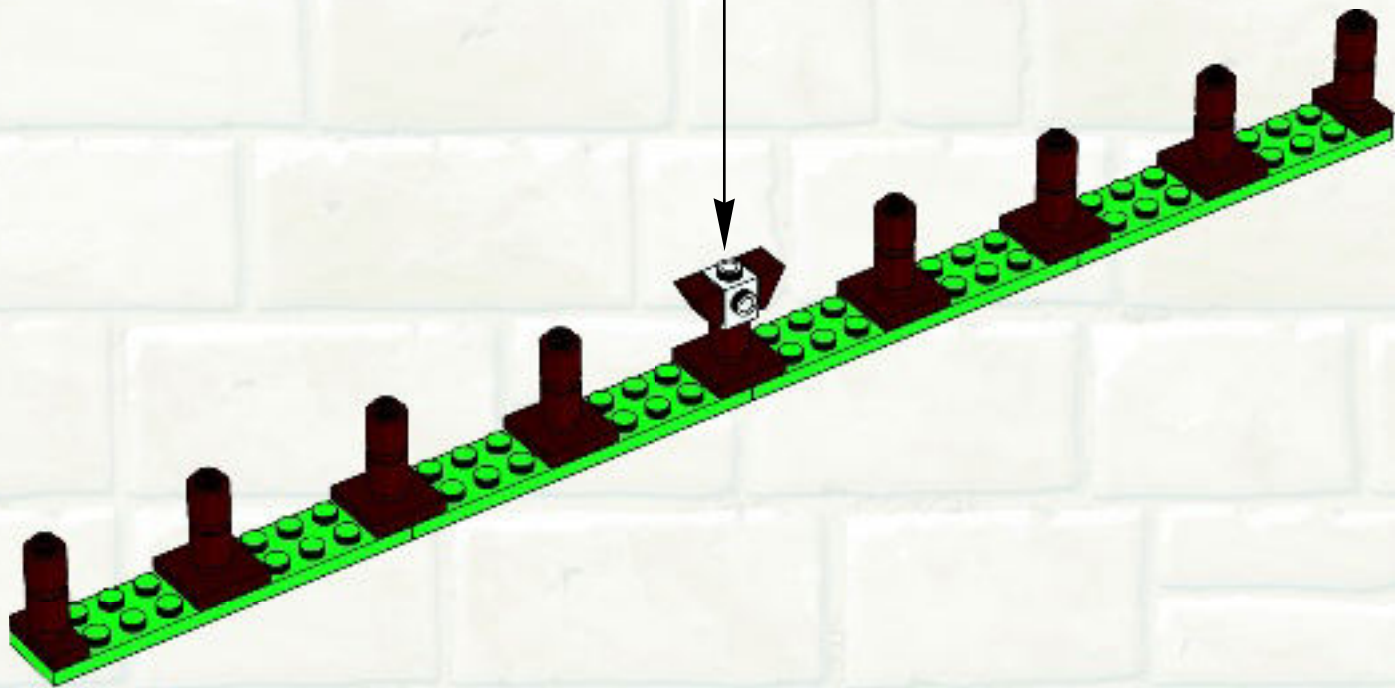



7

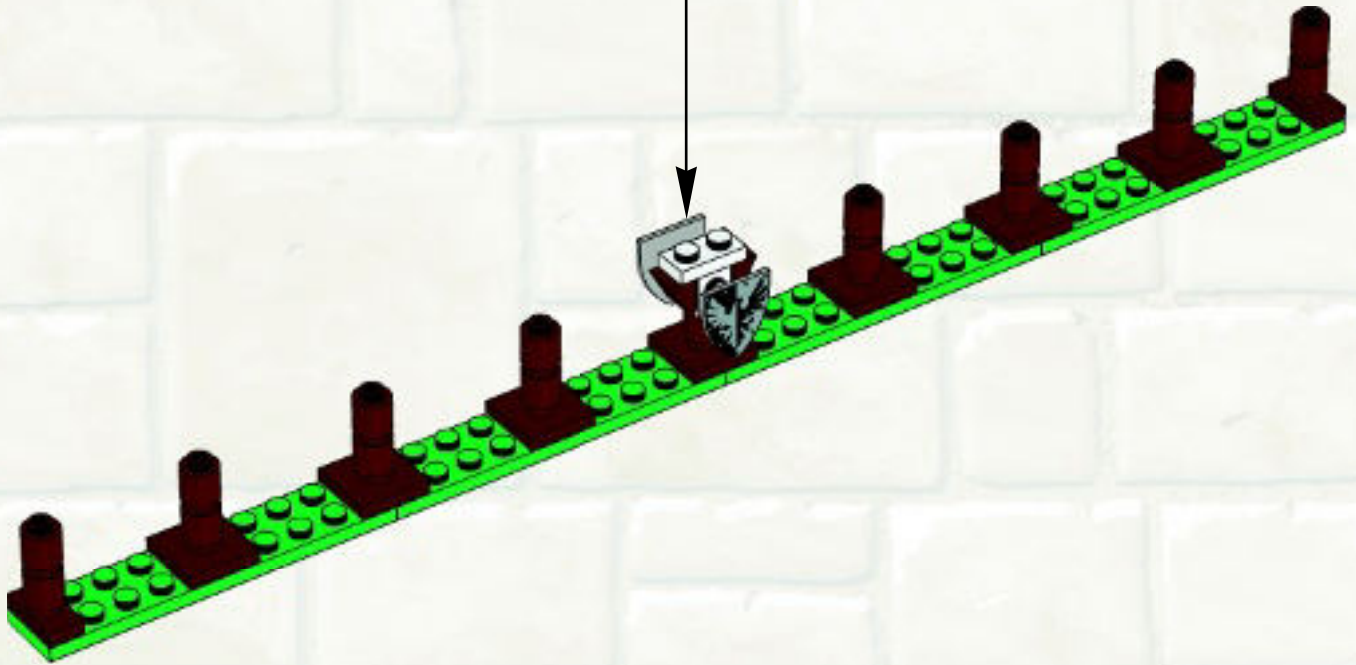

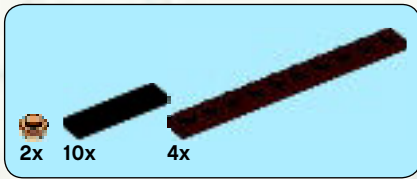

8

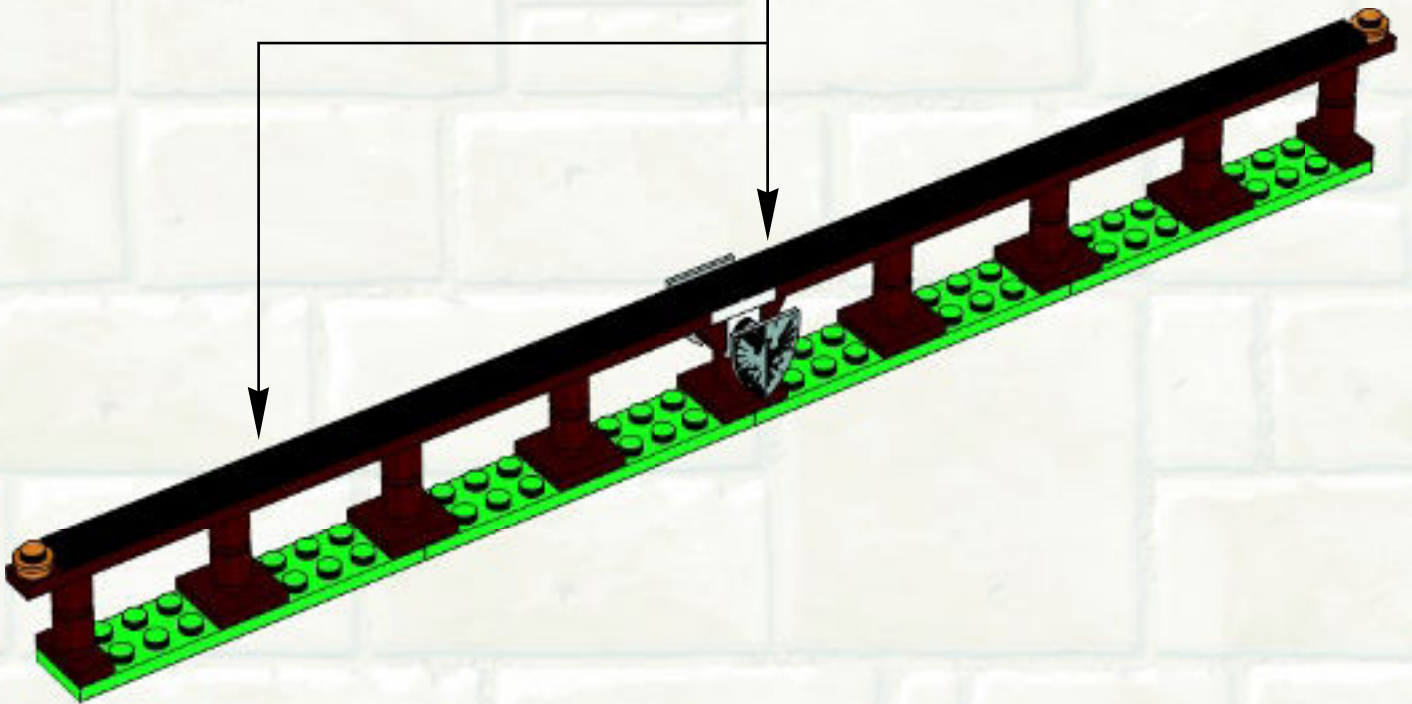
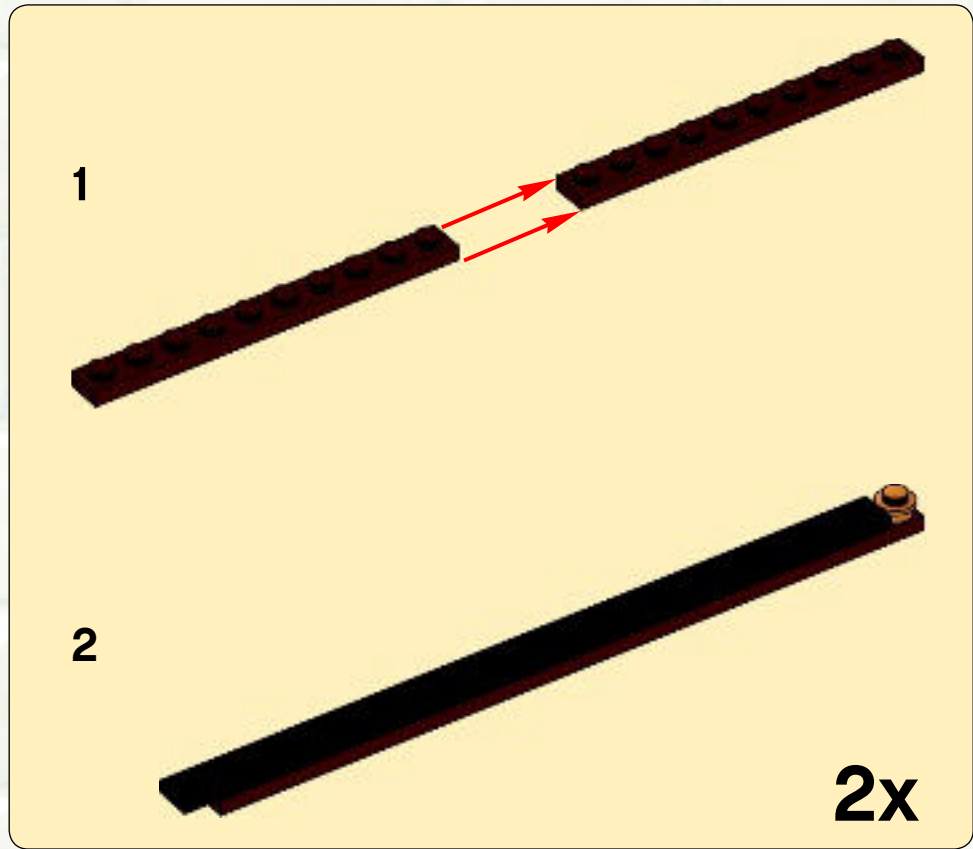

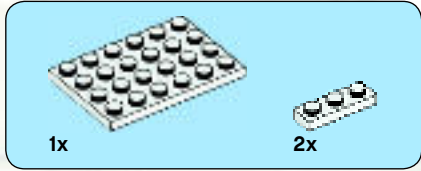

1

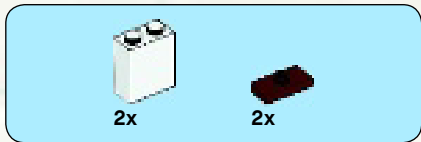
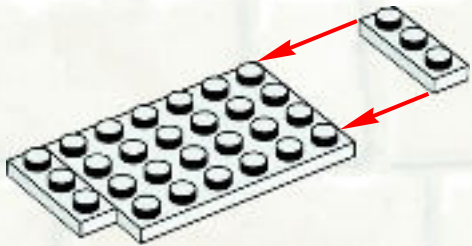

2

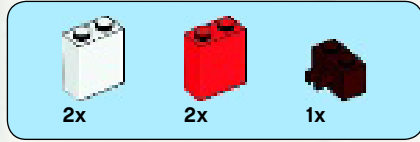
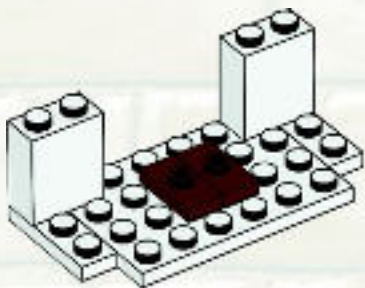

3

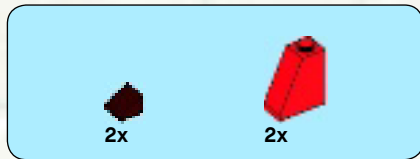
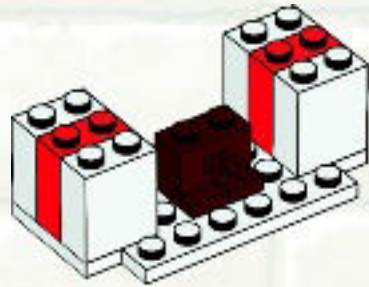

4

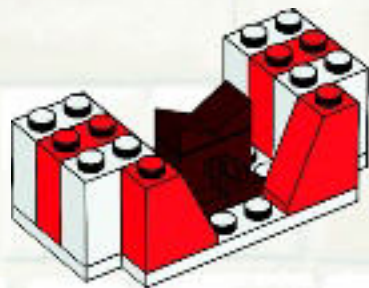

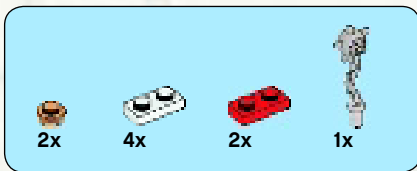

5

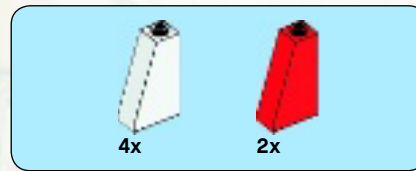
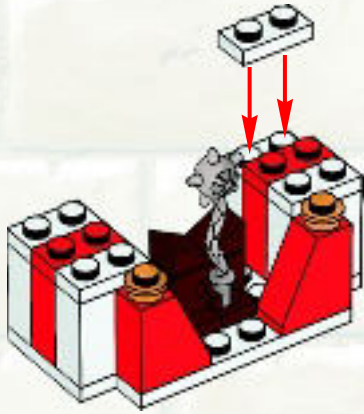

7

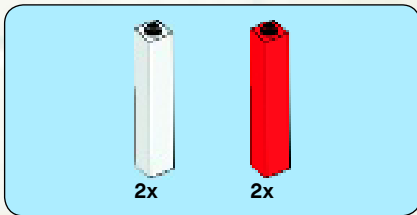
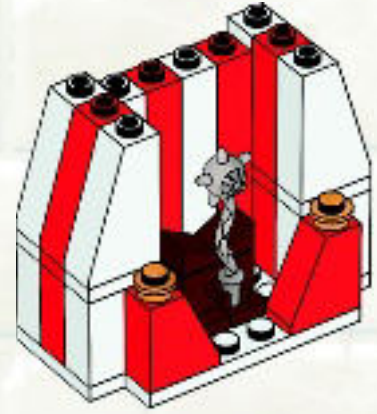

6

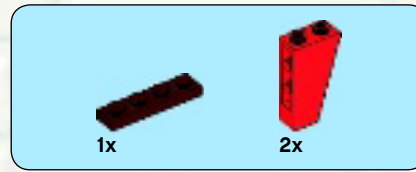
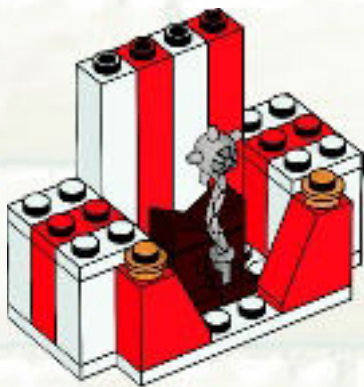

8



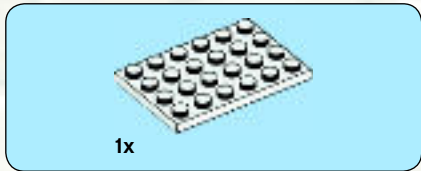

9



11



10



12

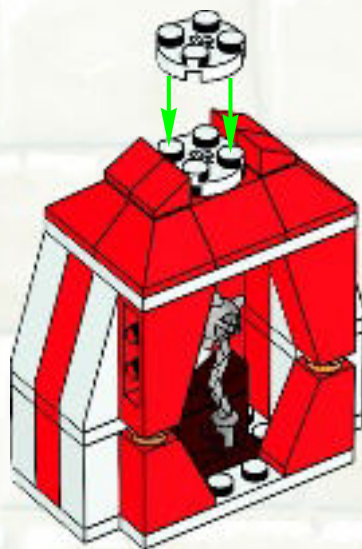

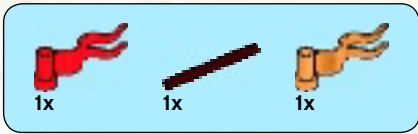

13

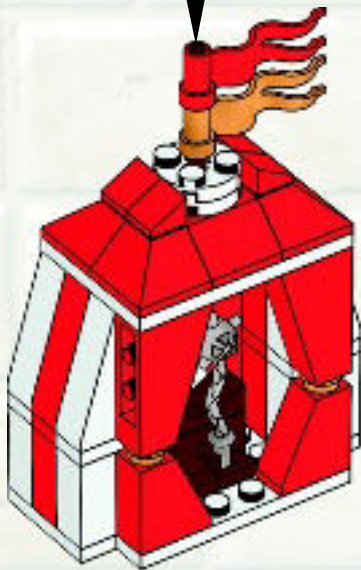
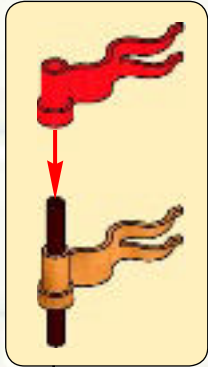

1

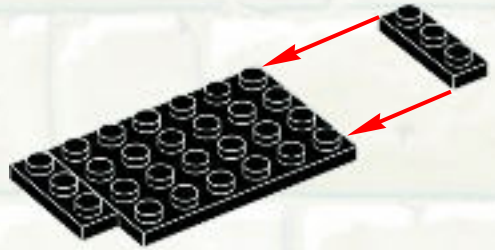

2

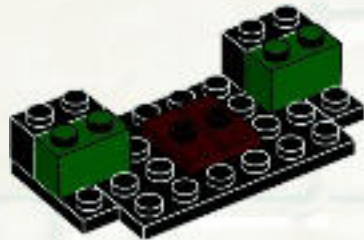



3

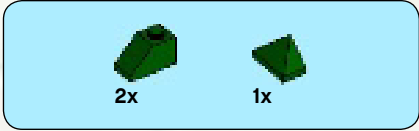
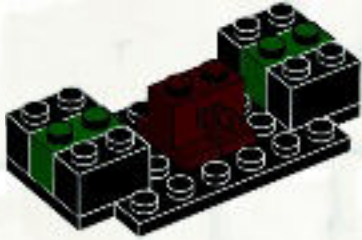

4

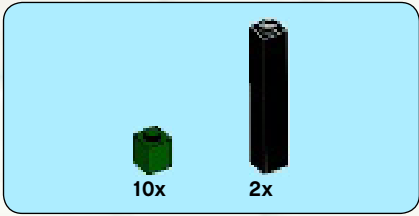
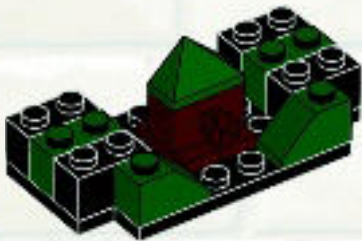

5

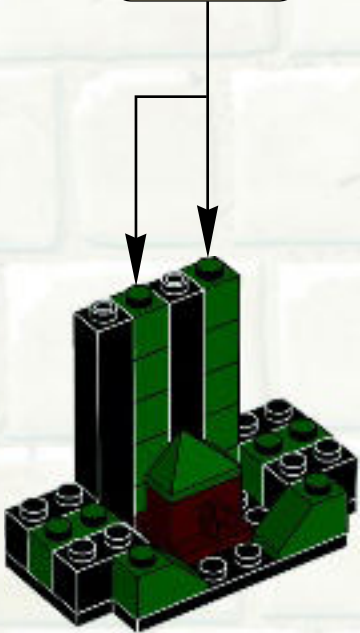
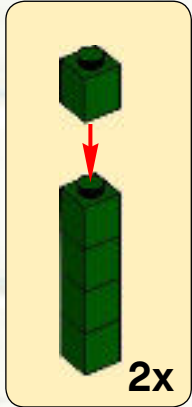

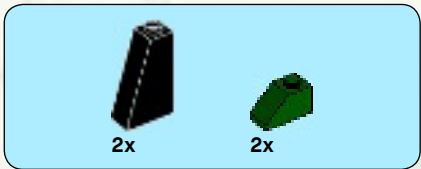

6

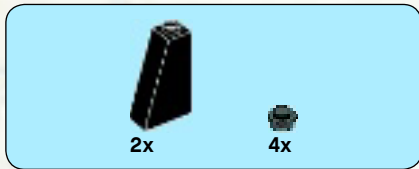
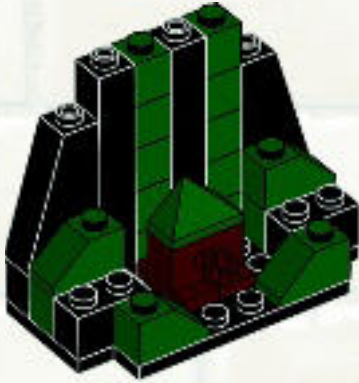

8

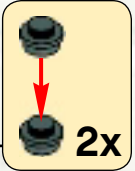
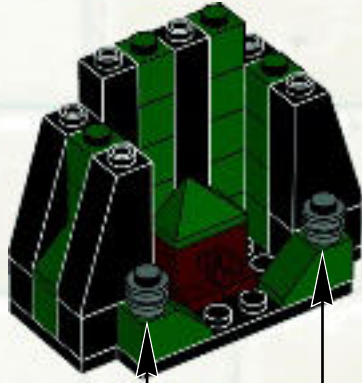

7

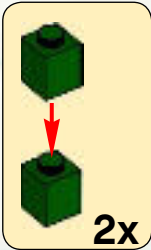
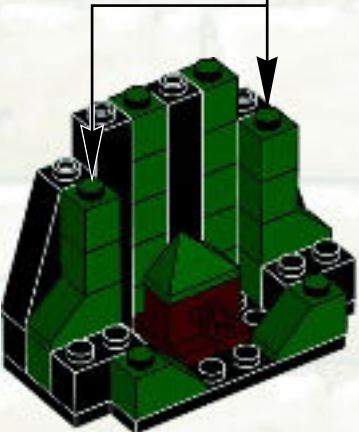

9

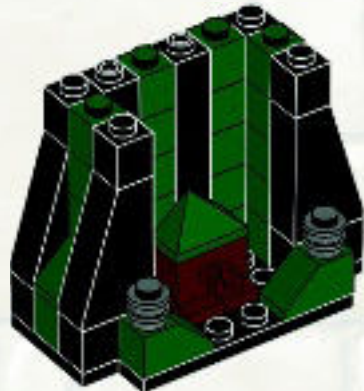



10

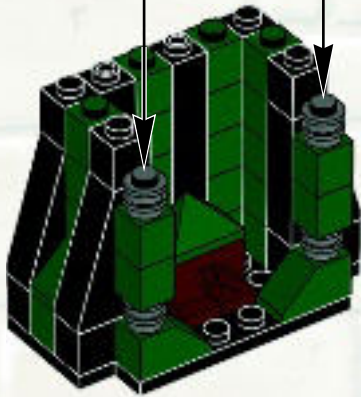
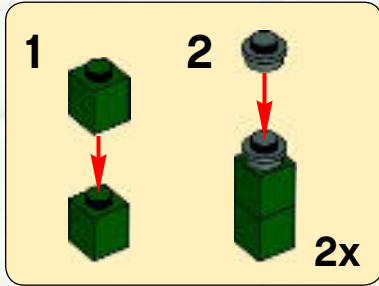

11

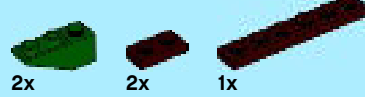
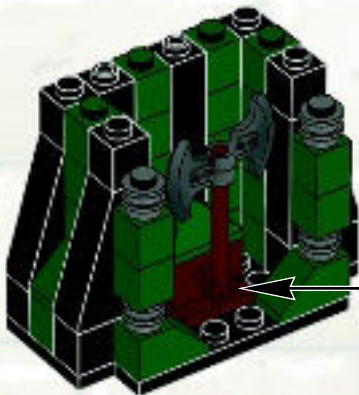

12

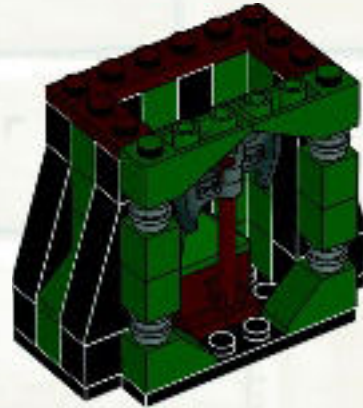

13





14

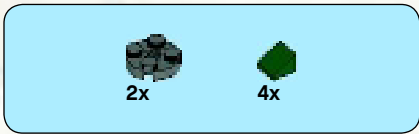

16

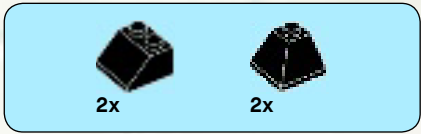
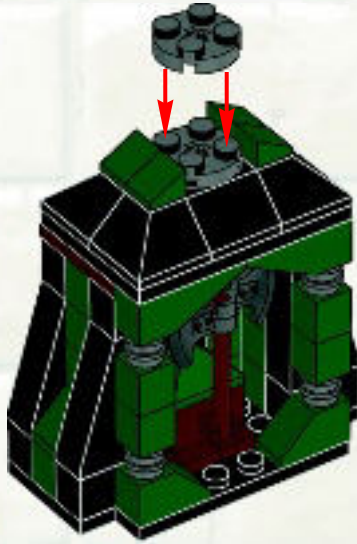

15



17

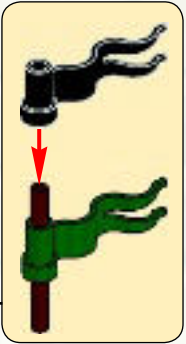
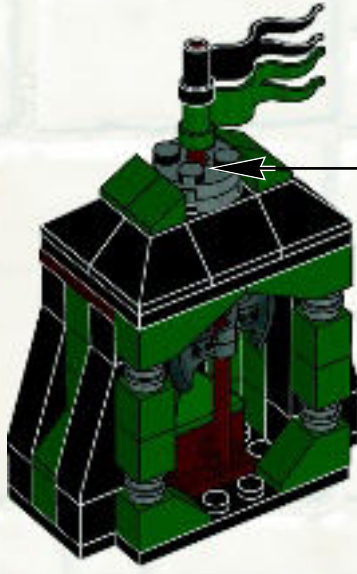

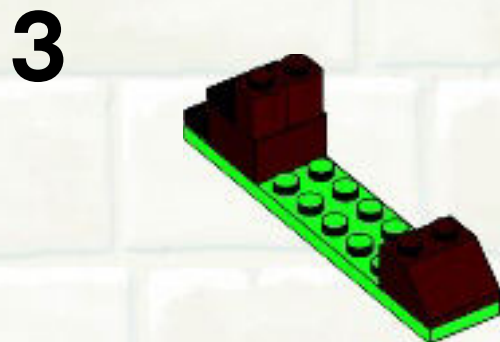
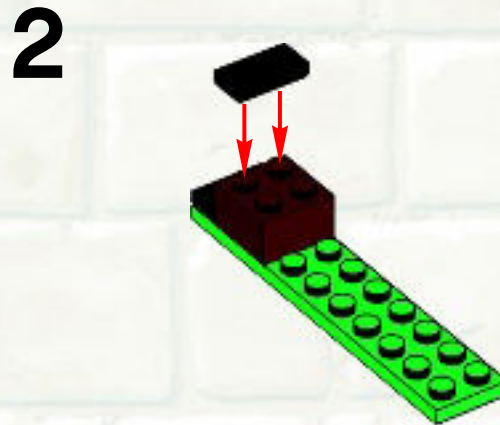
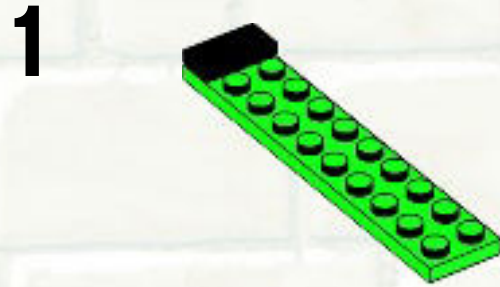
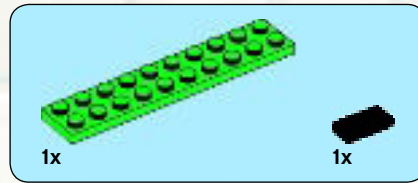
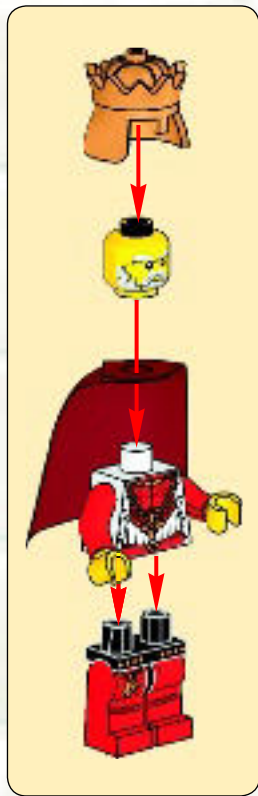
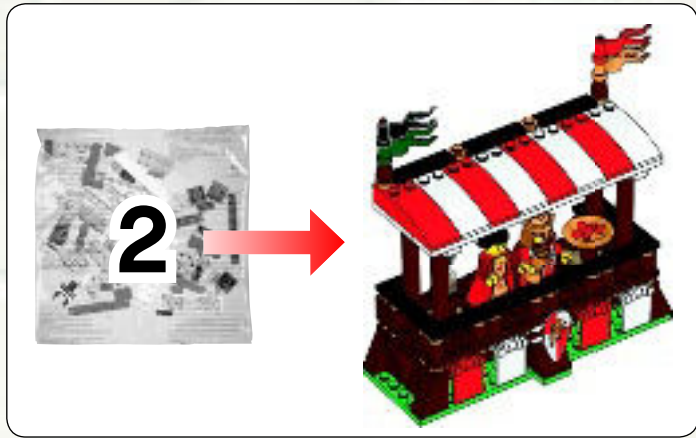

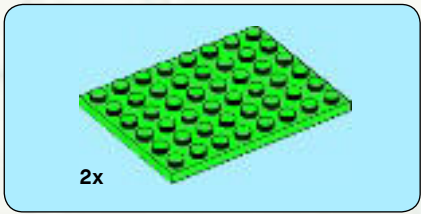

4

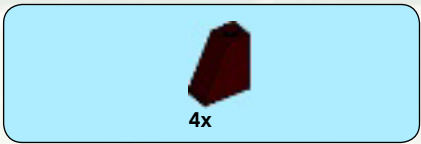
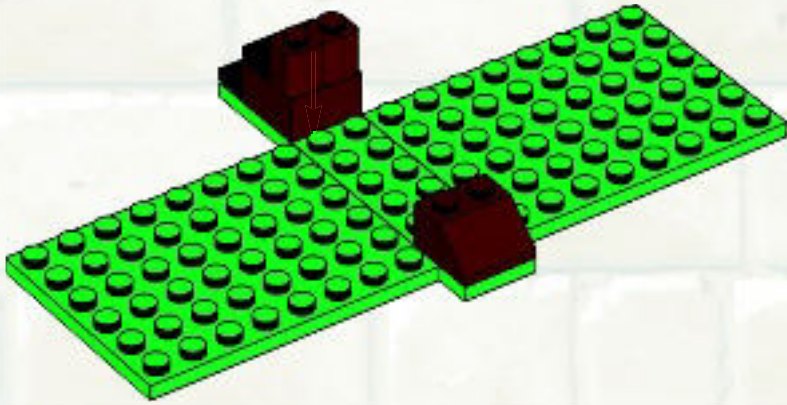

5

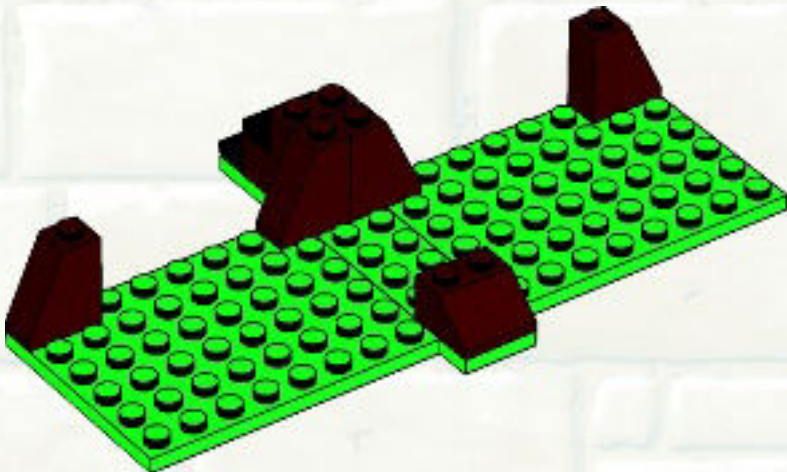

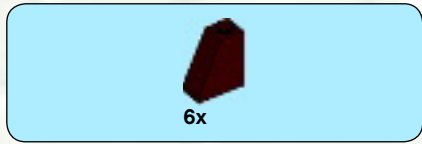

6

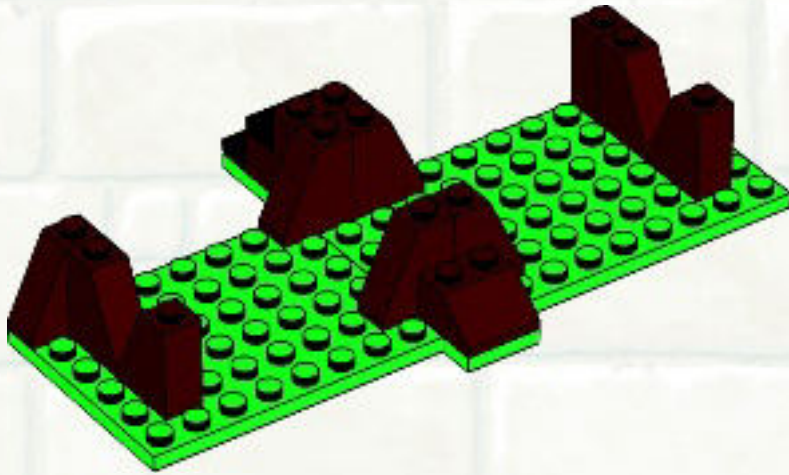

7

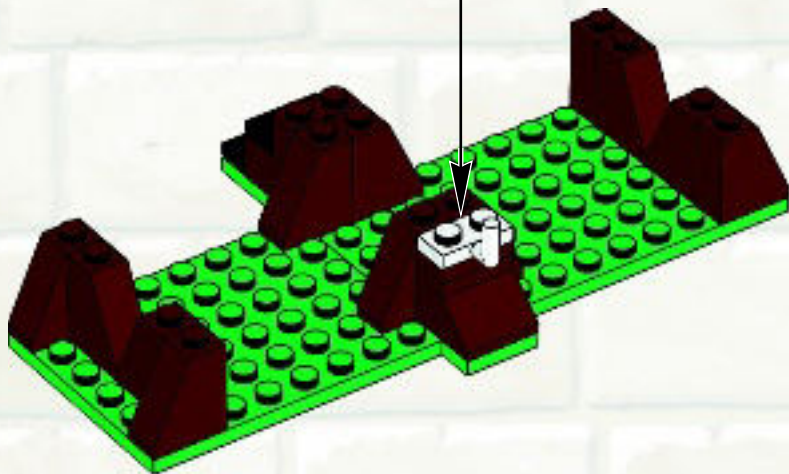
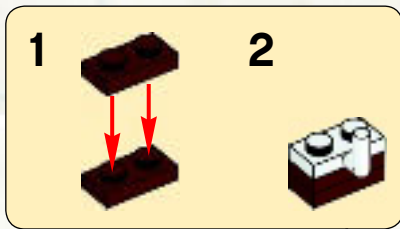

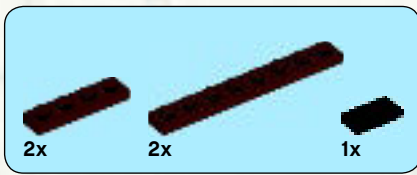

8

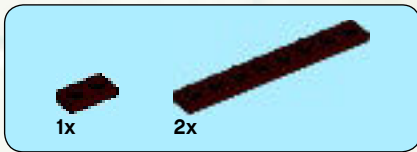
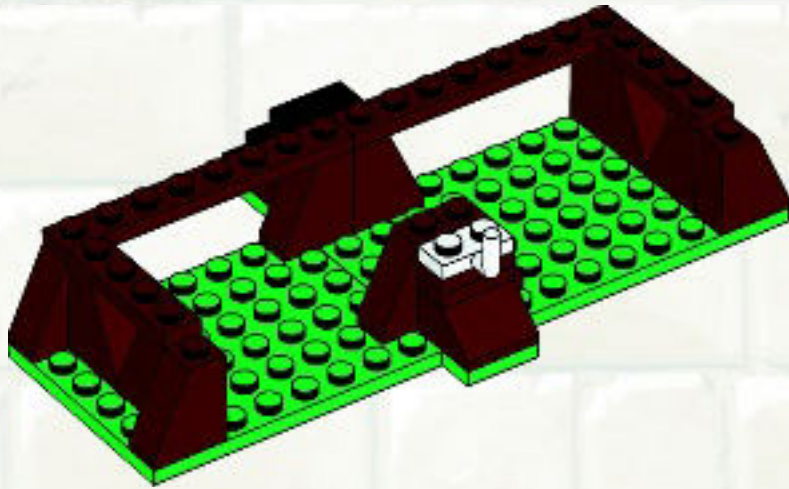

9

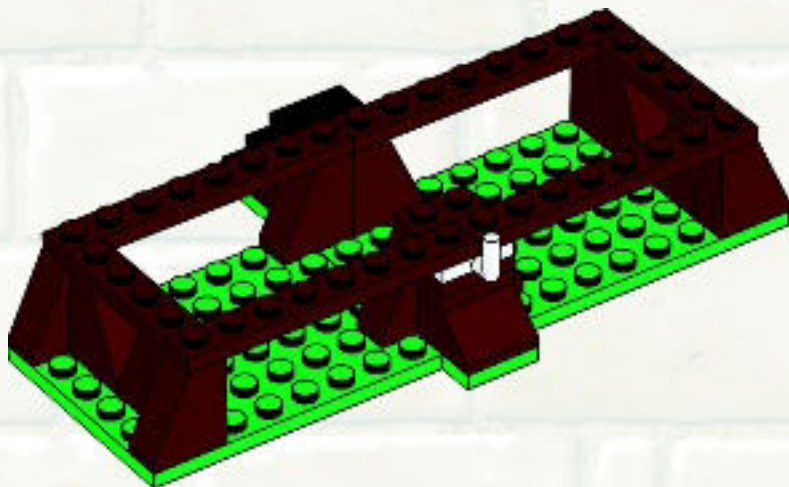

2x 3x 8x

10

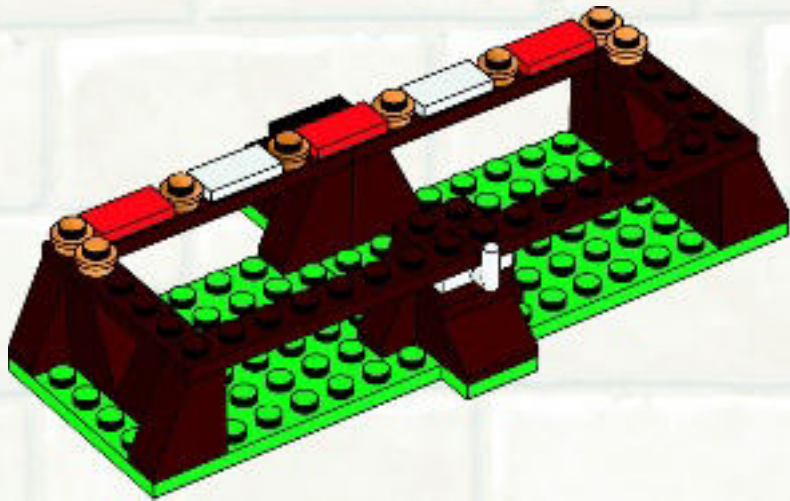

1x 2x 2x 8x

11

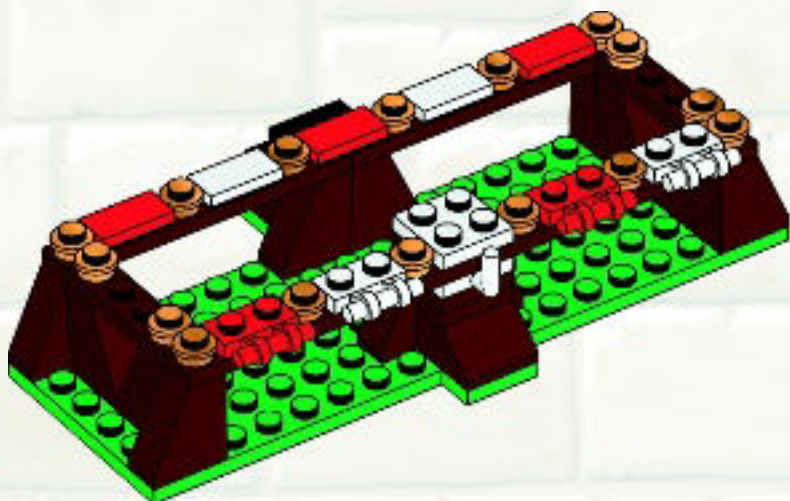

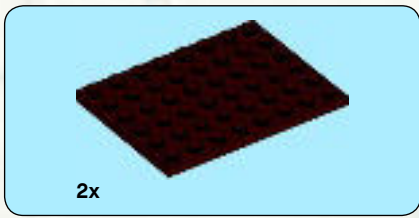

12

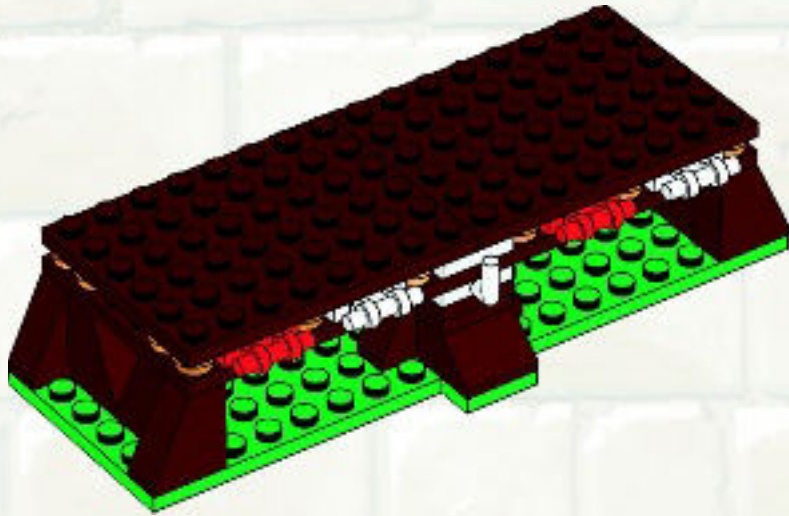

13





14

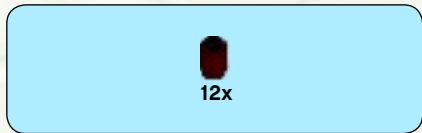
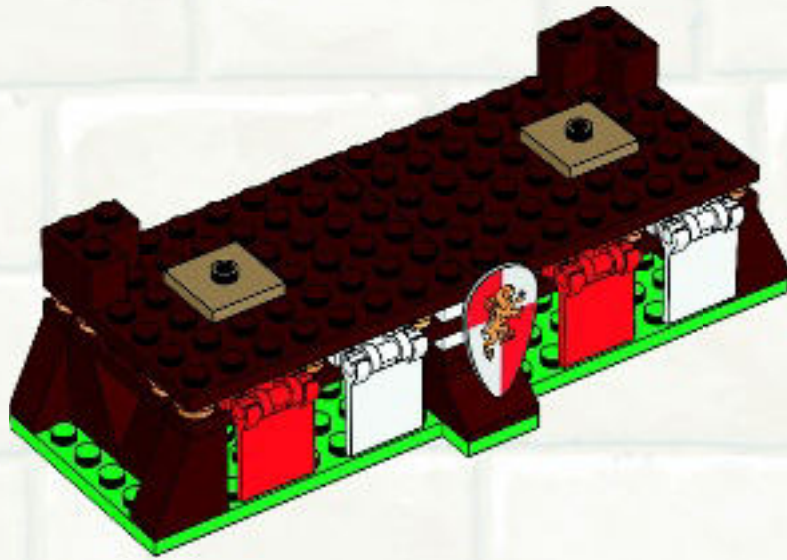

15

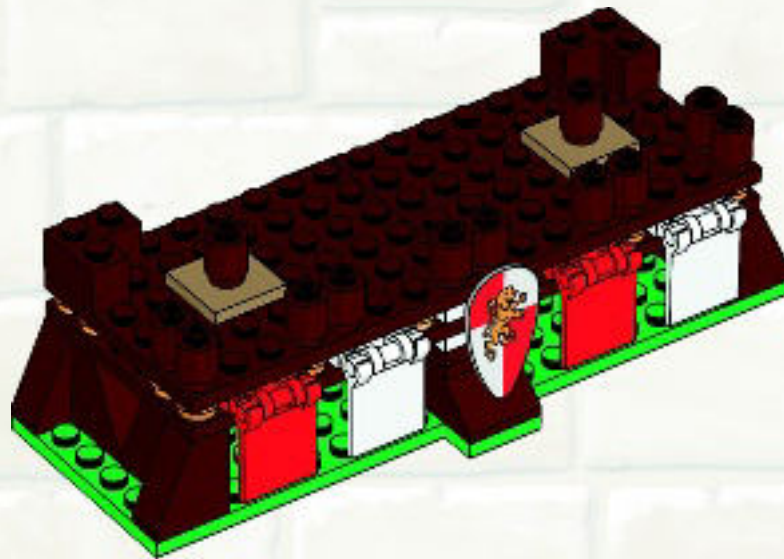

16x

16

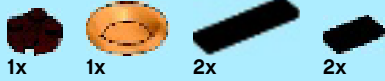

17



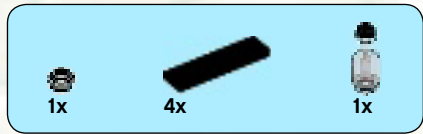

18

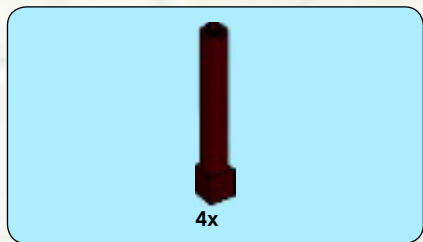
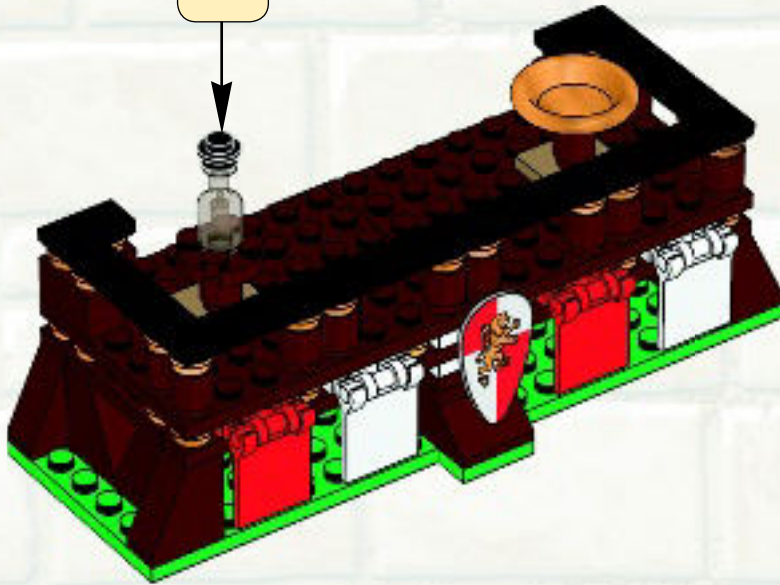

19

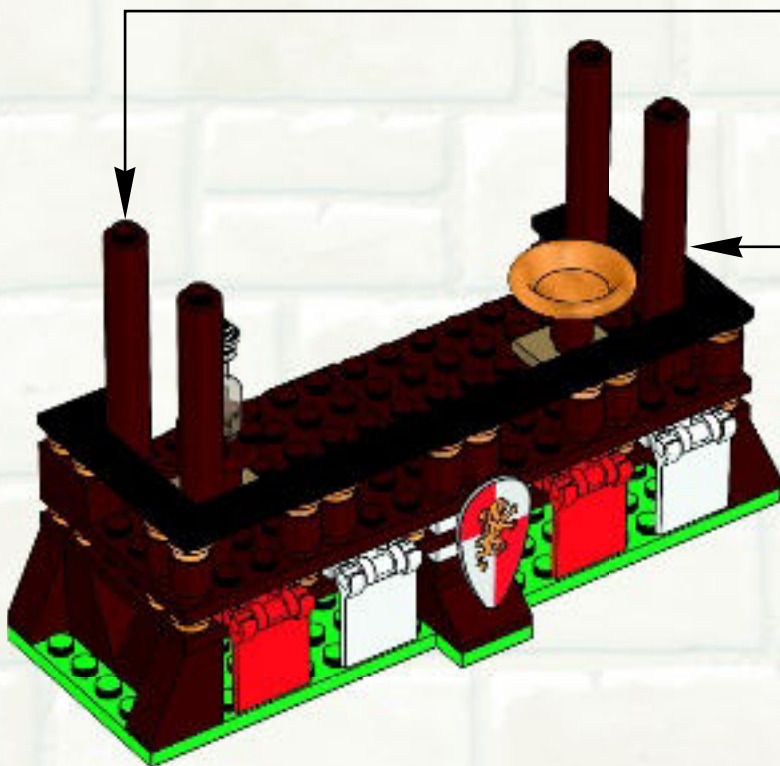
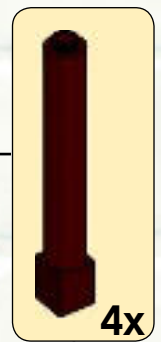



2x



2x

20



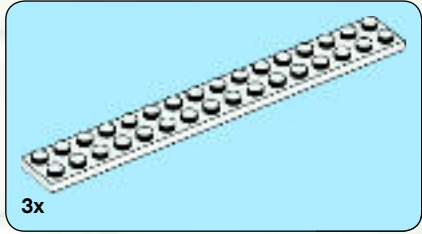

1

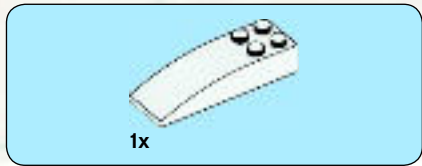
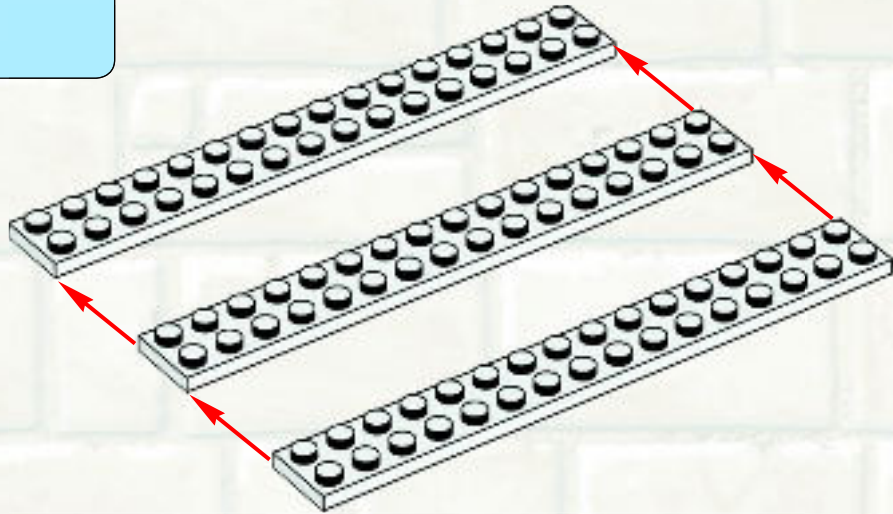

2

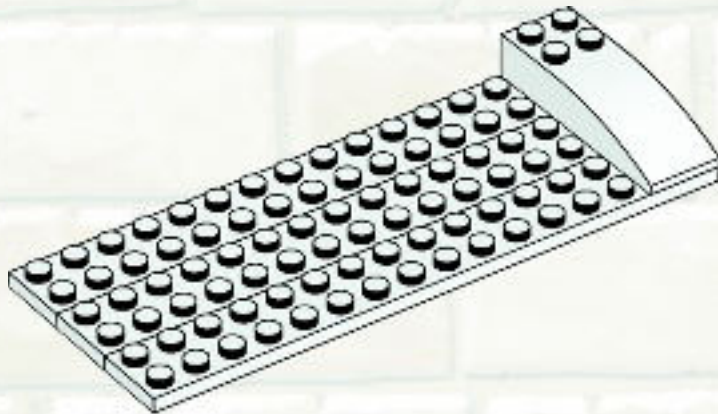

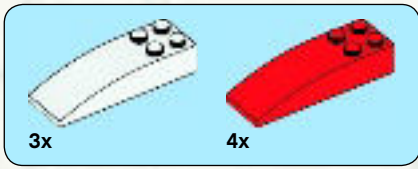

3

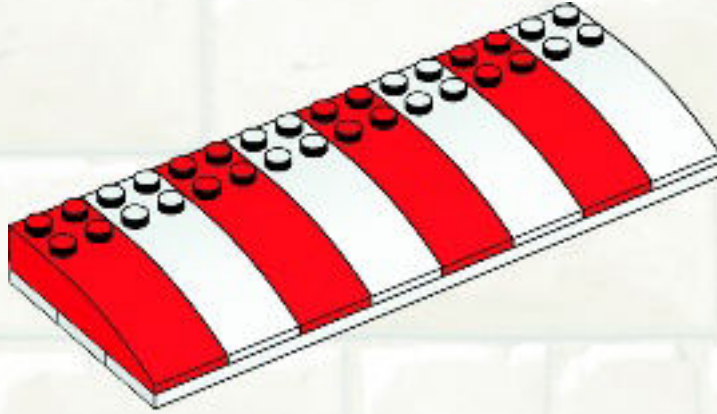

4

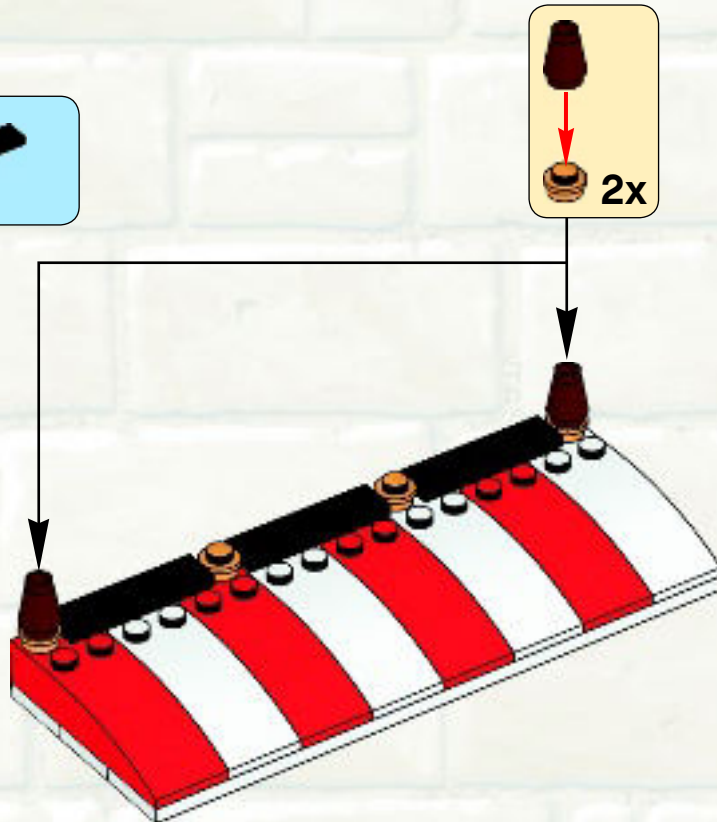

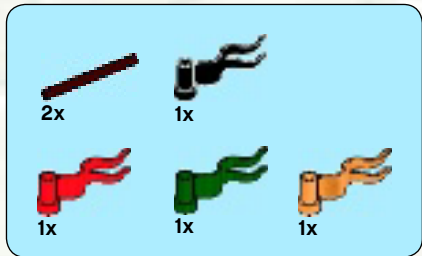

5

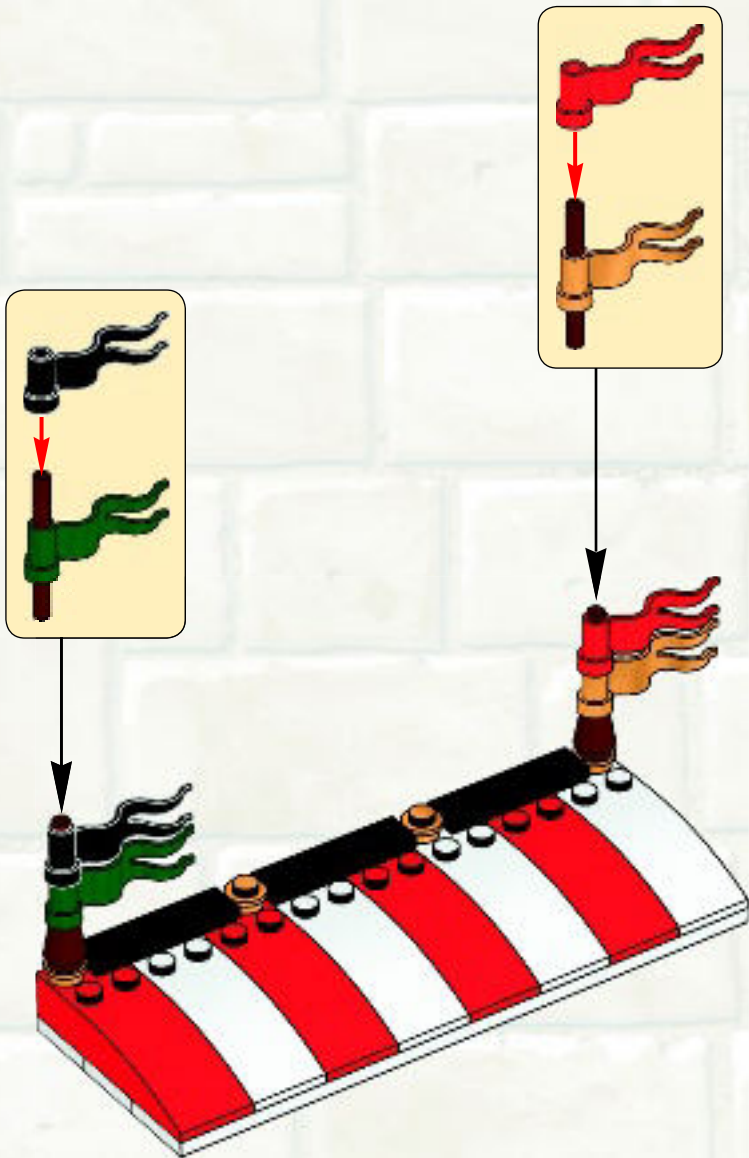

21



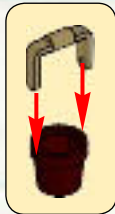
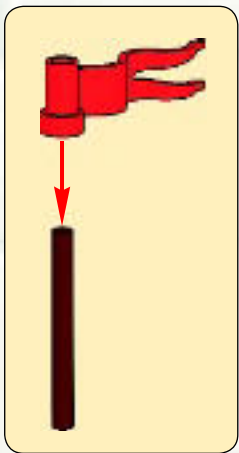
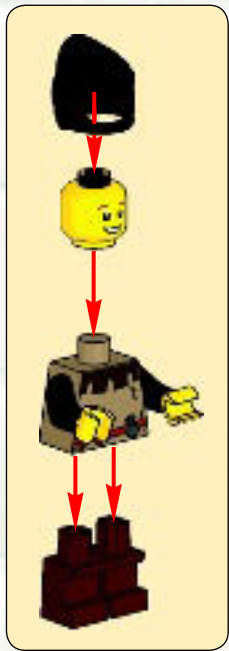
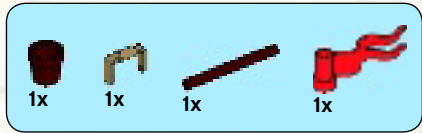
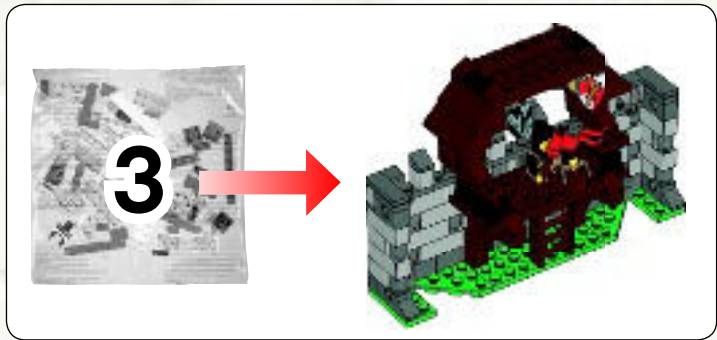

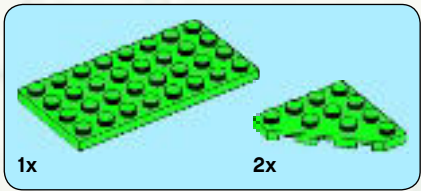

1

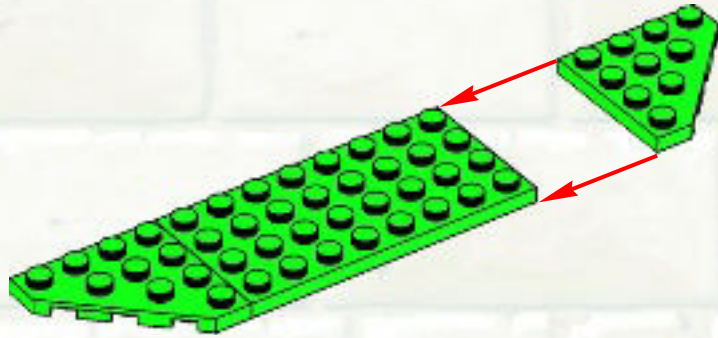

2

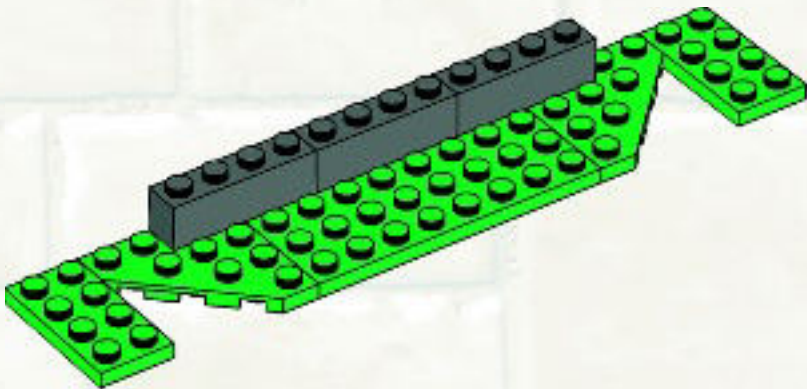



3

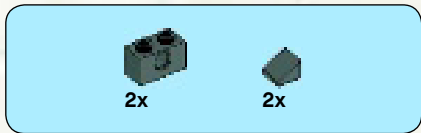
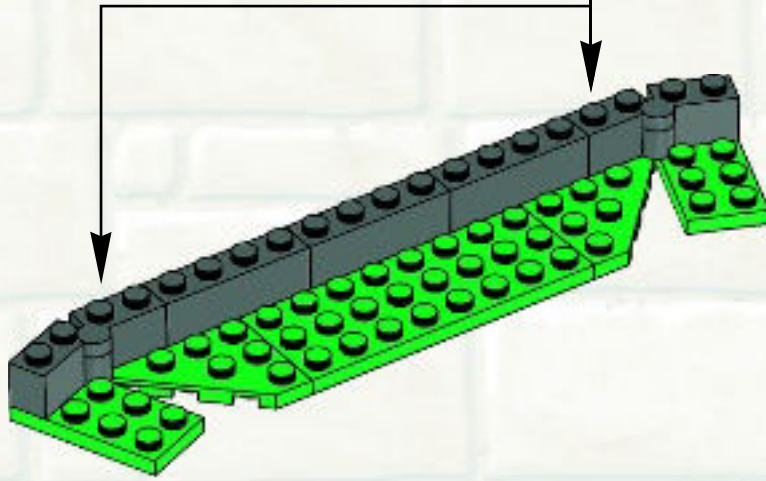
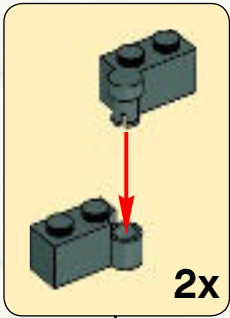

4

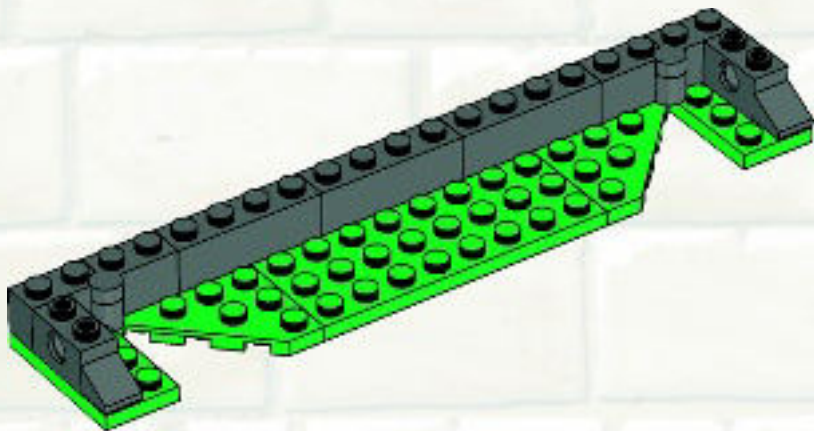



5

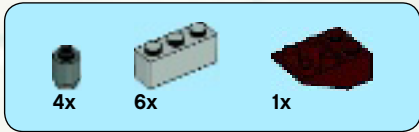
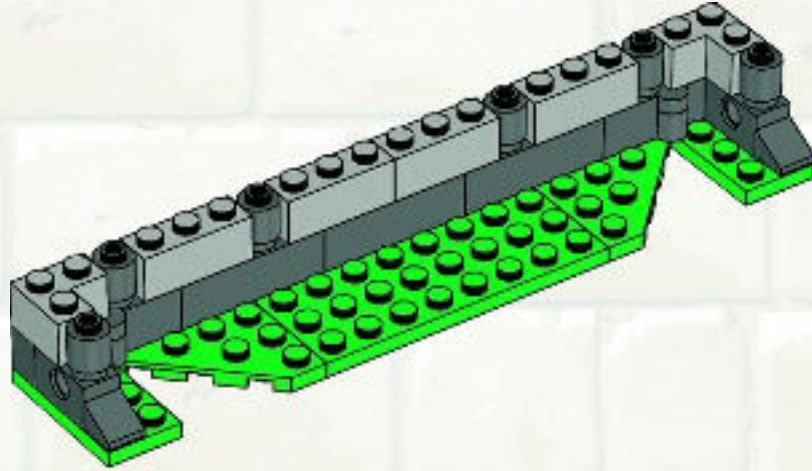

6

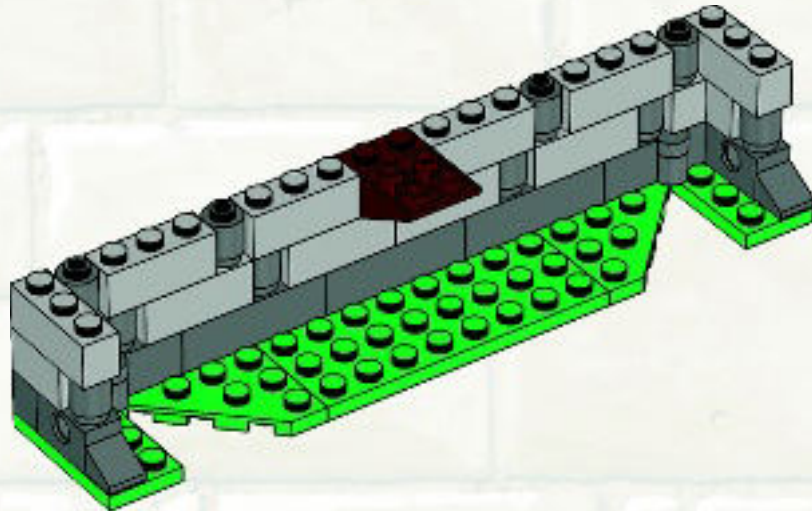



7

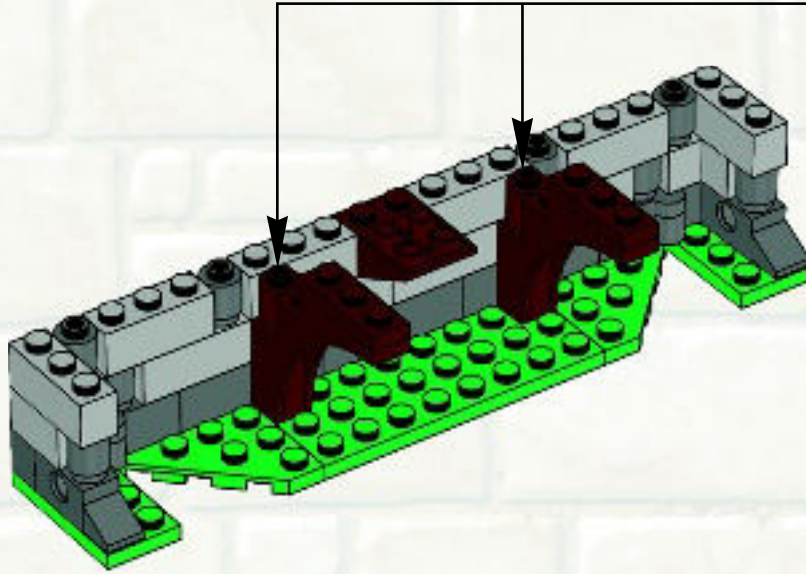
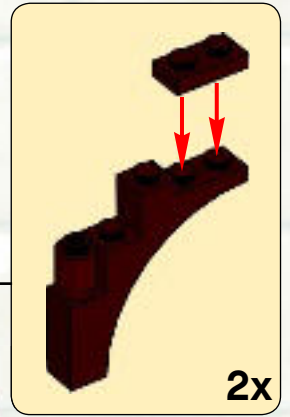

8

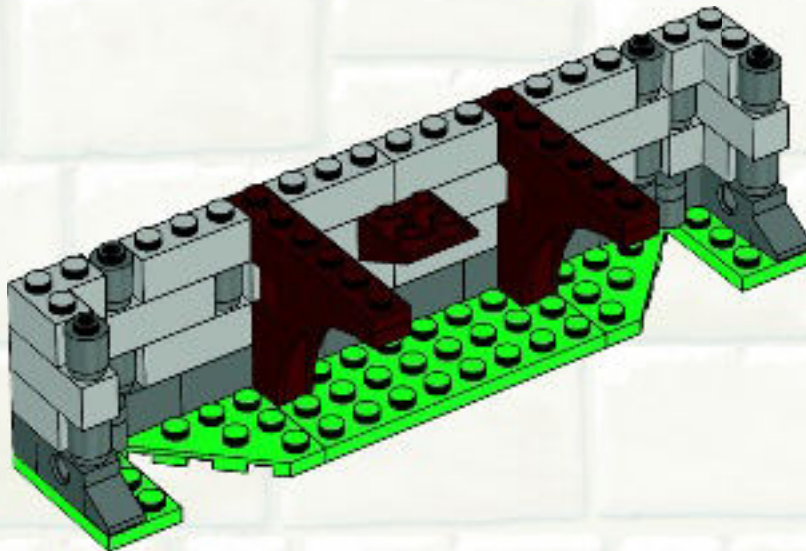

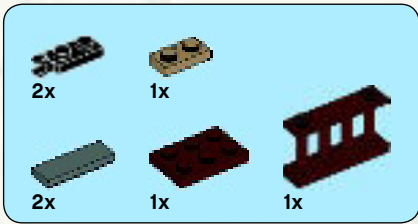

9

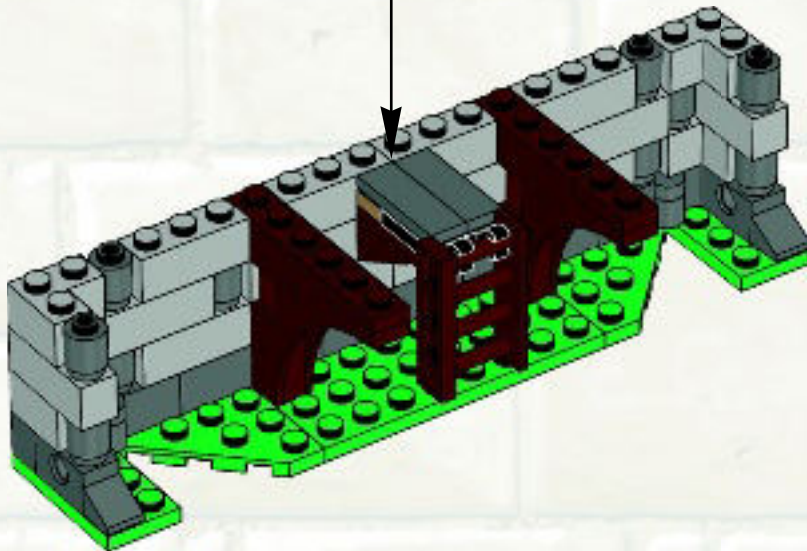
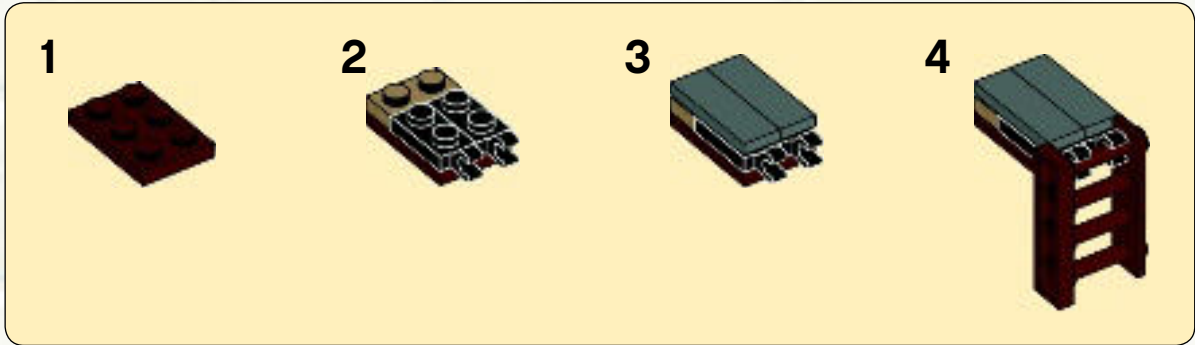



10

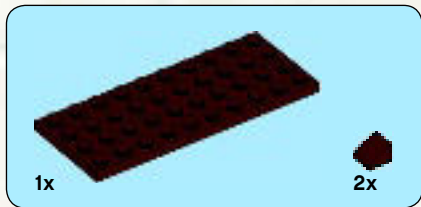
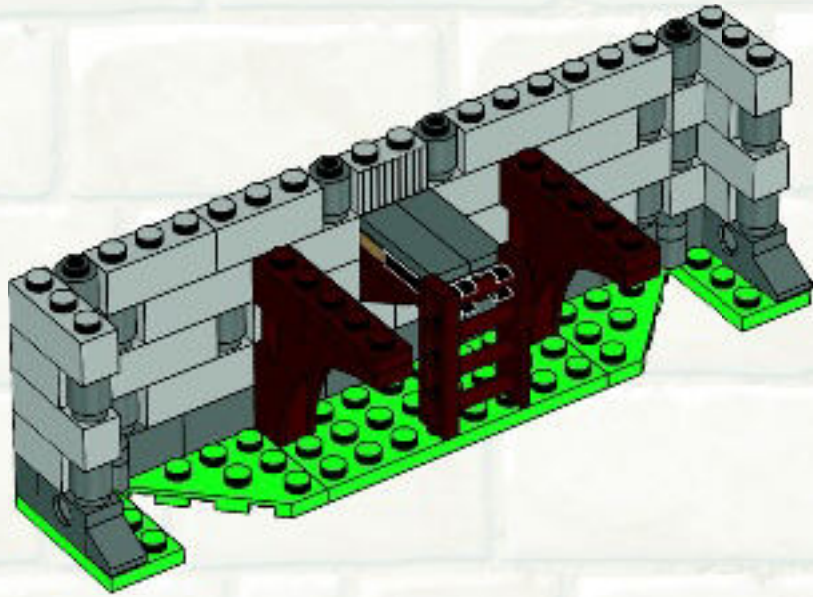

11

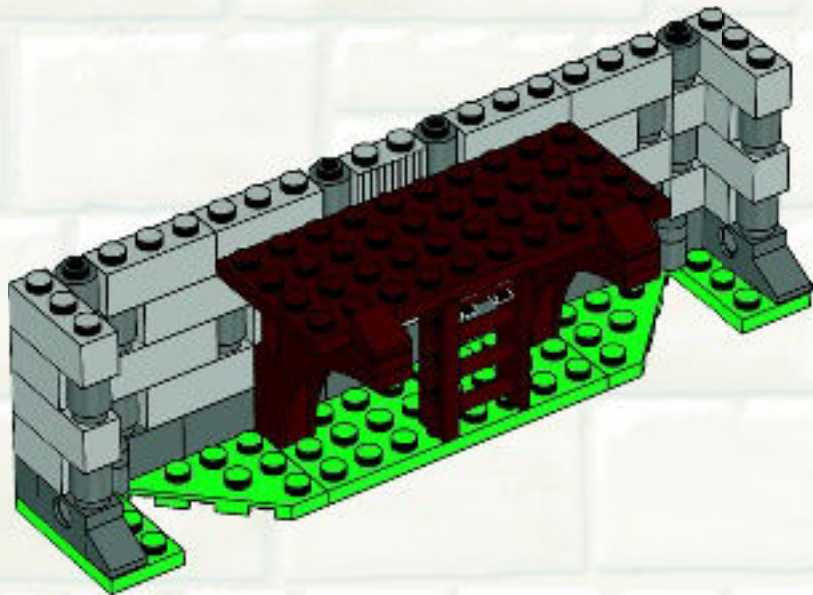

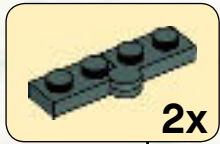
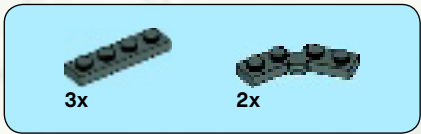

12

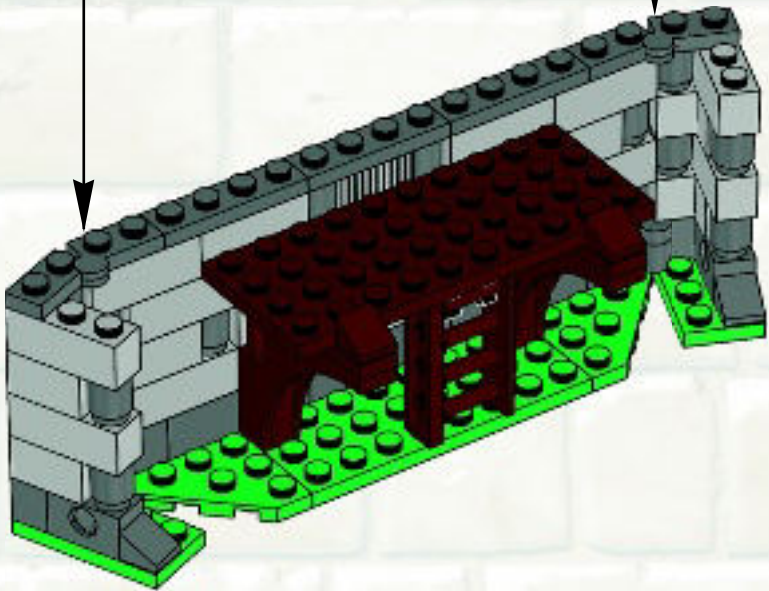

13

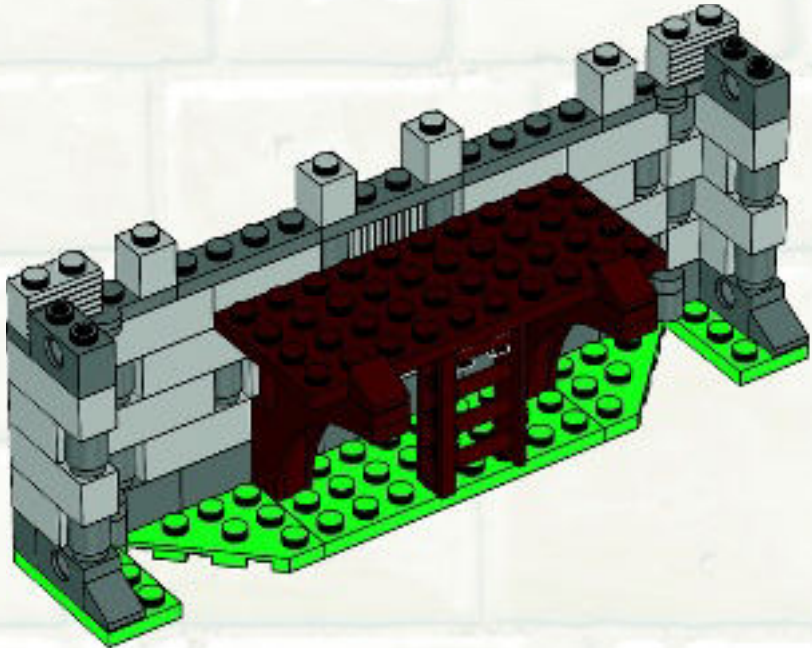

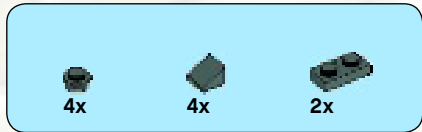

14

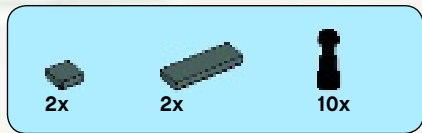
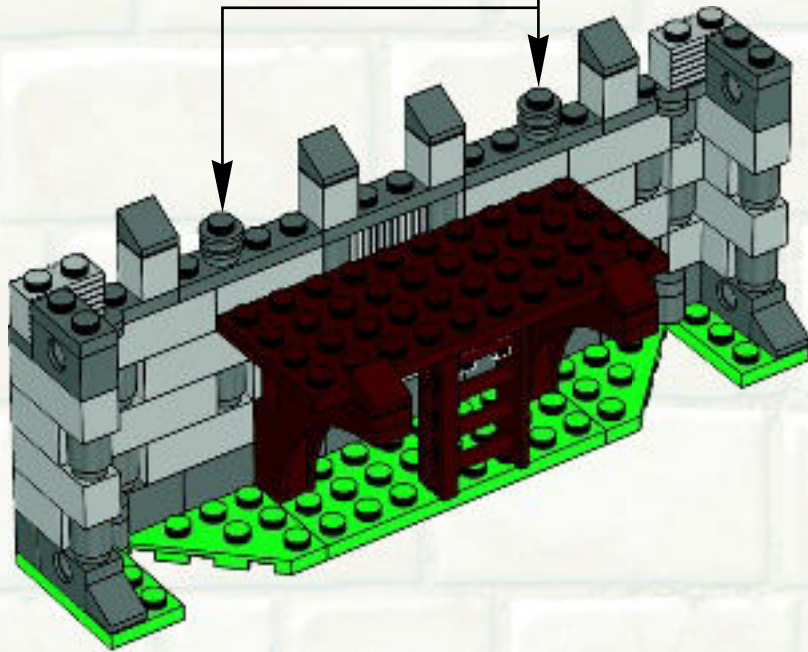
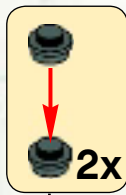

15

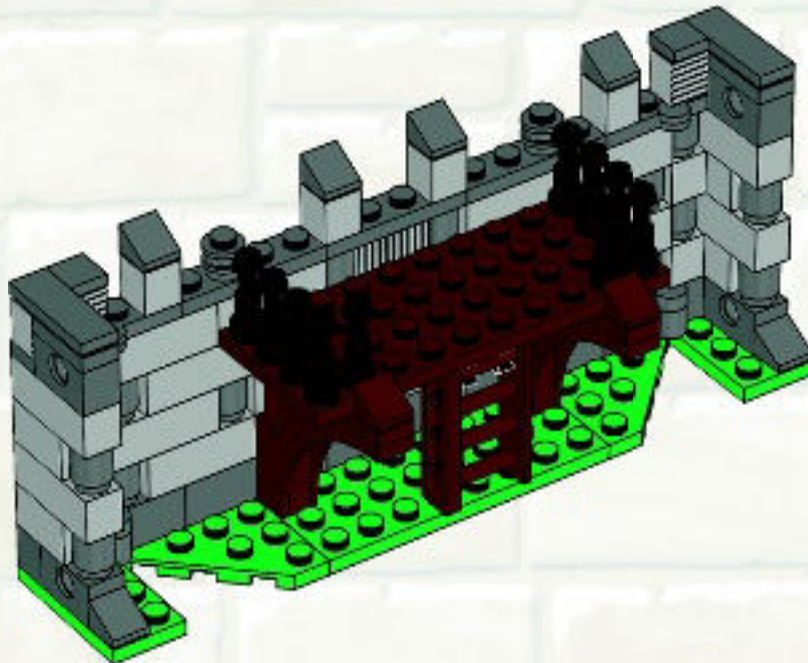

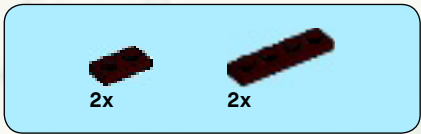

16

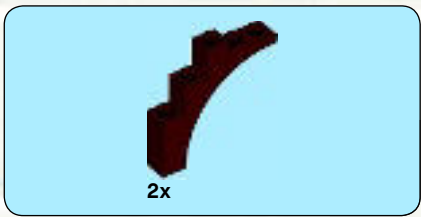
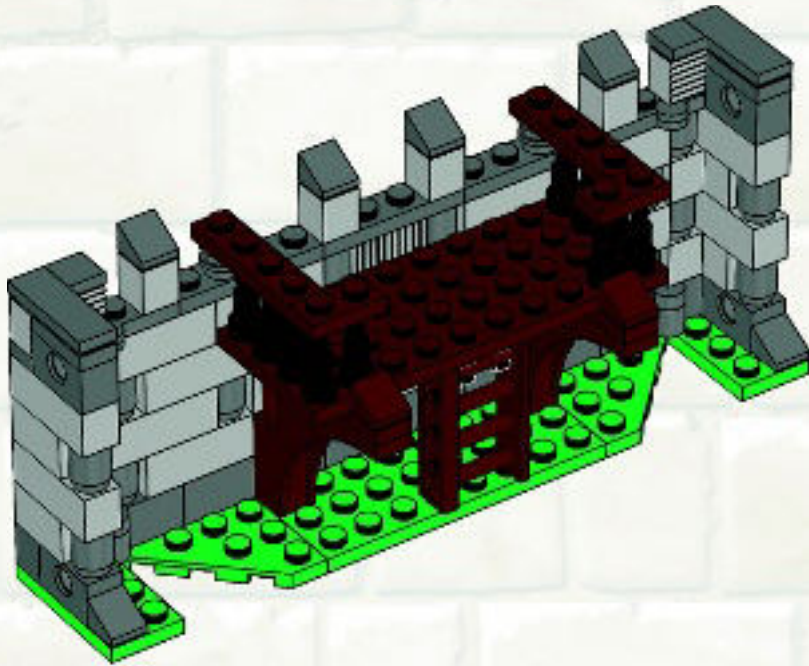

17

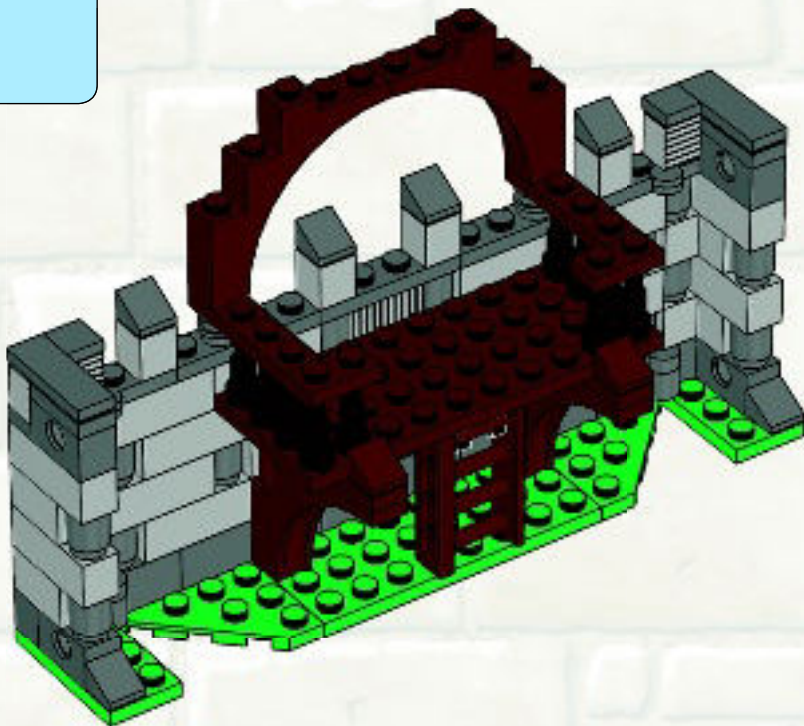

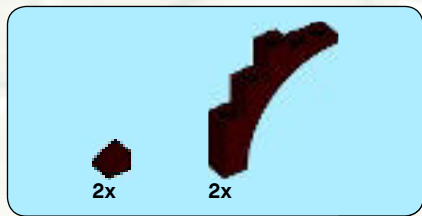

18

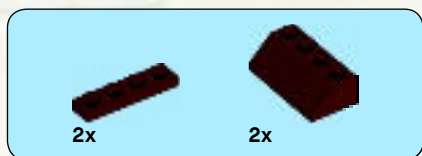
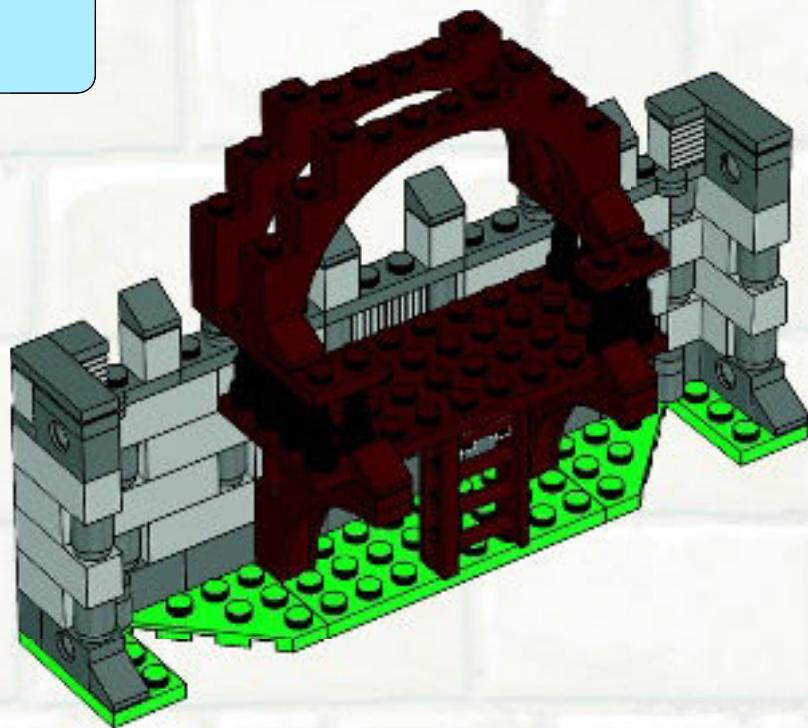

19

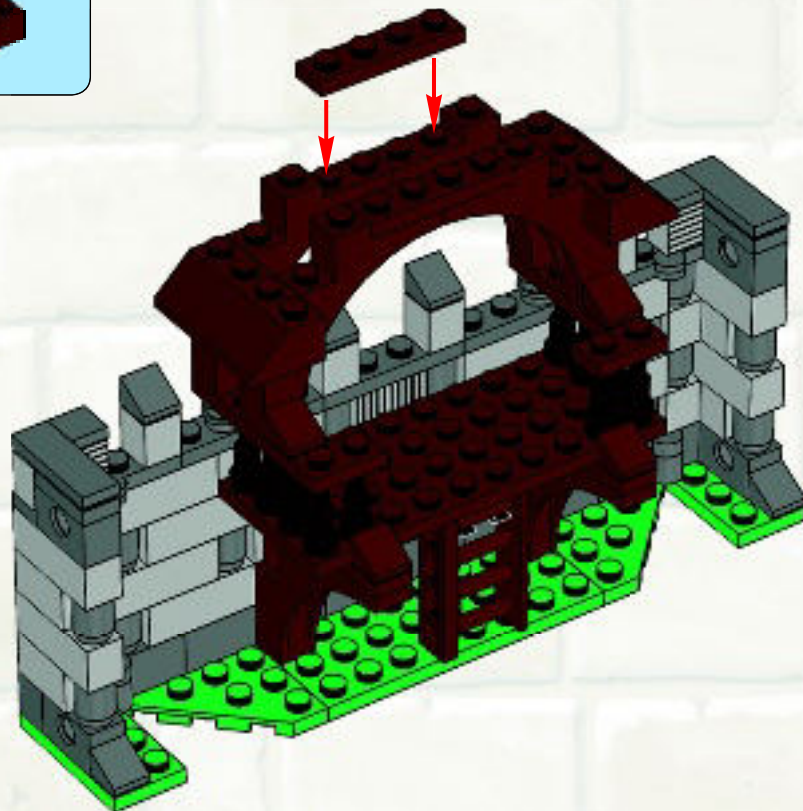

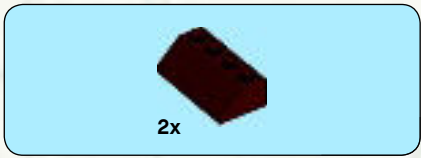

20

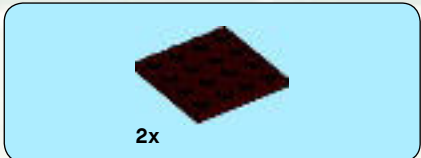
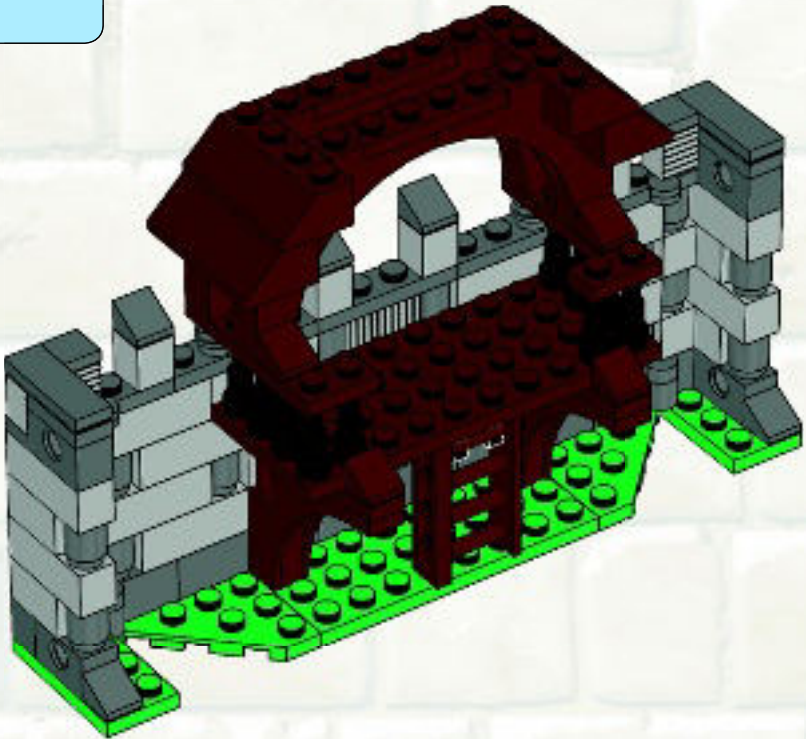

21

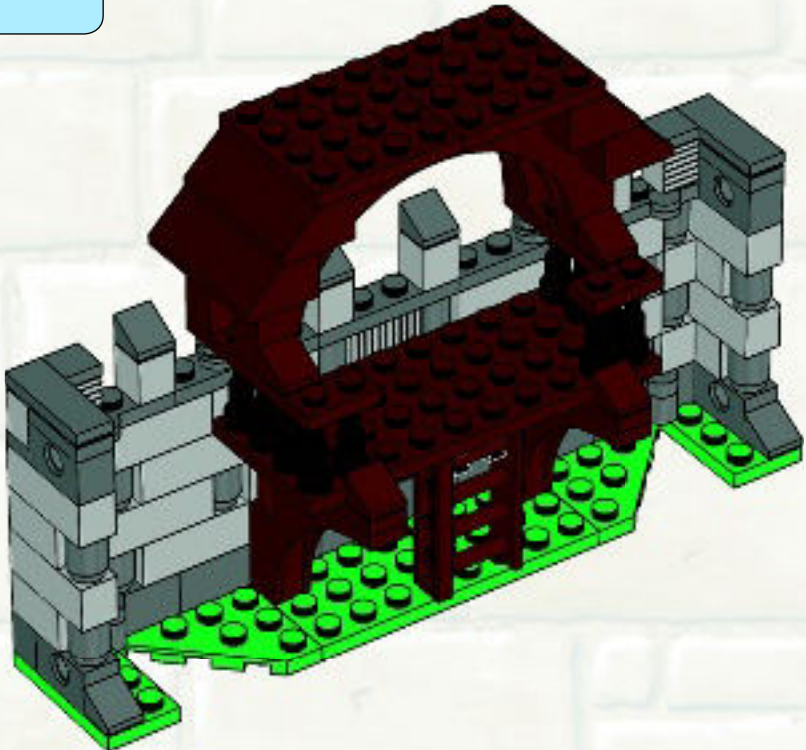

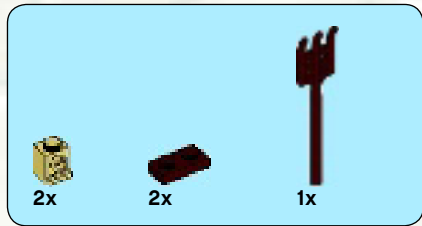

22

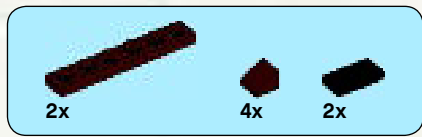
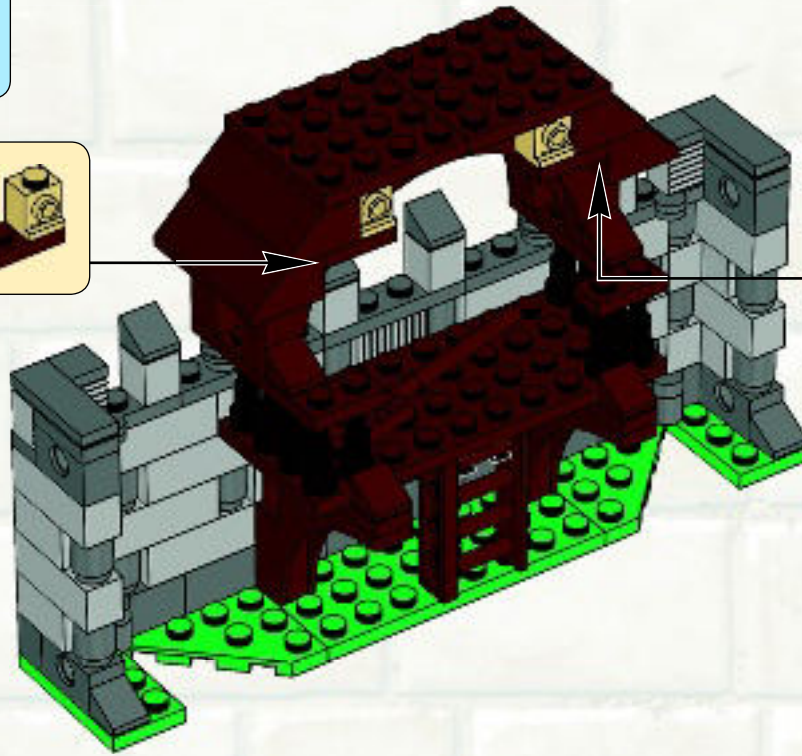

23

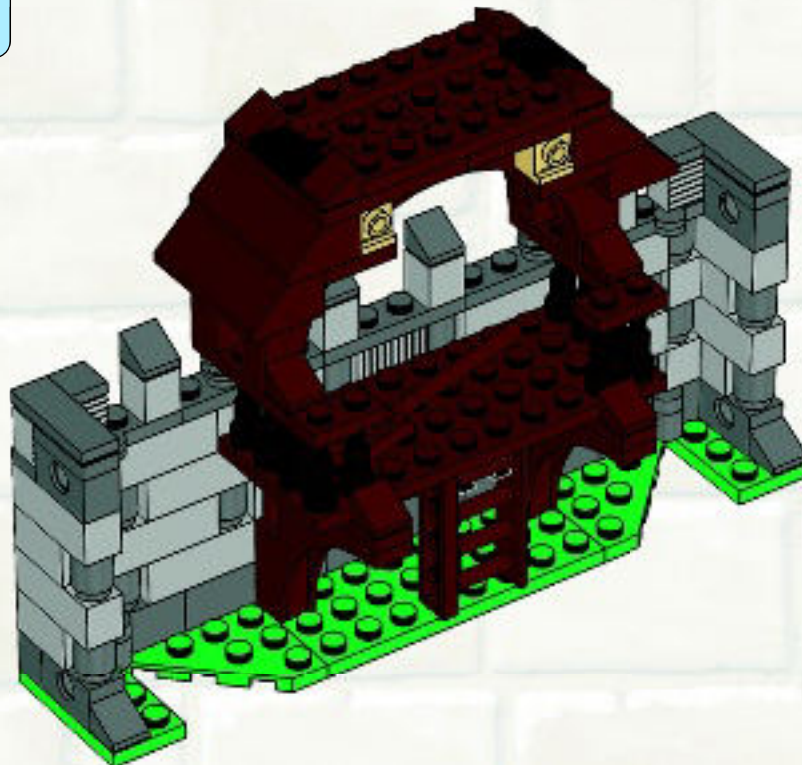



1x



1x

24

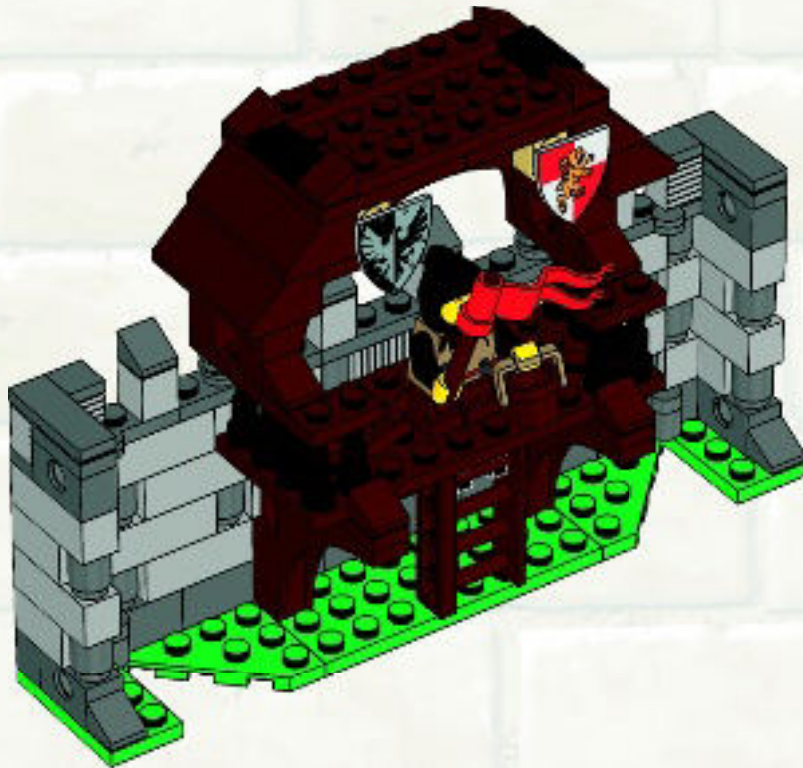

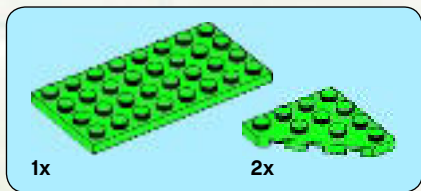
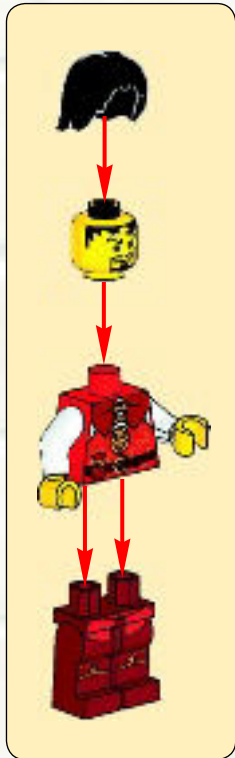
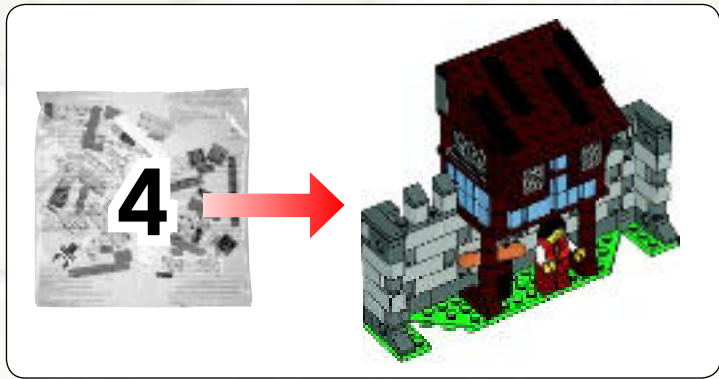

1

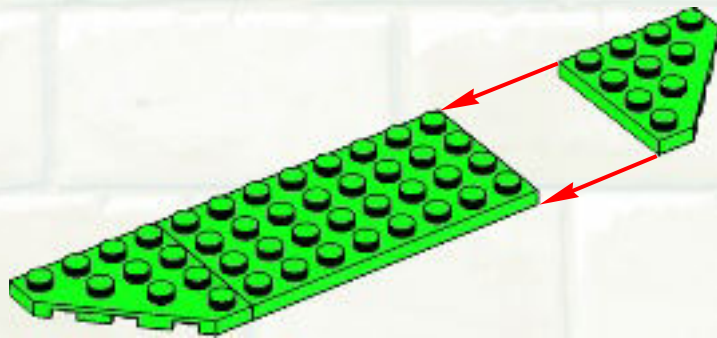

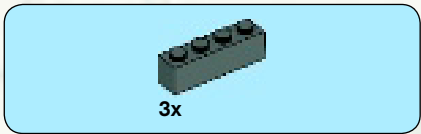

2

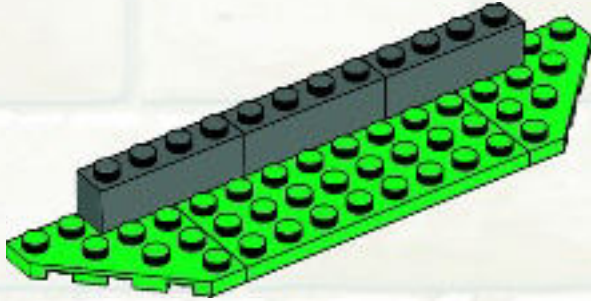

3

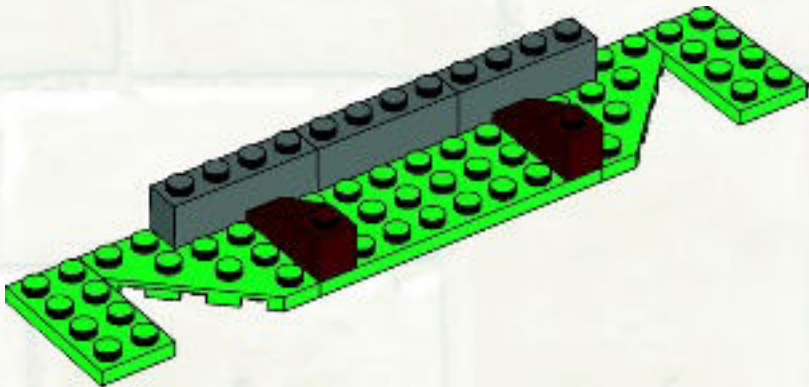



4

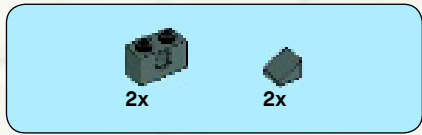
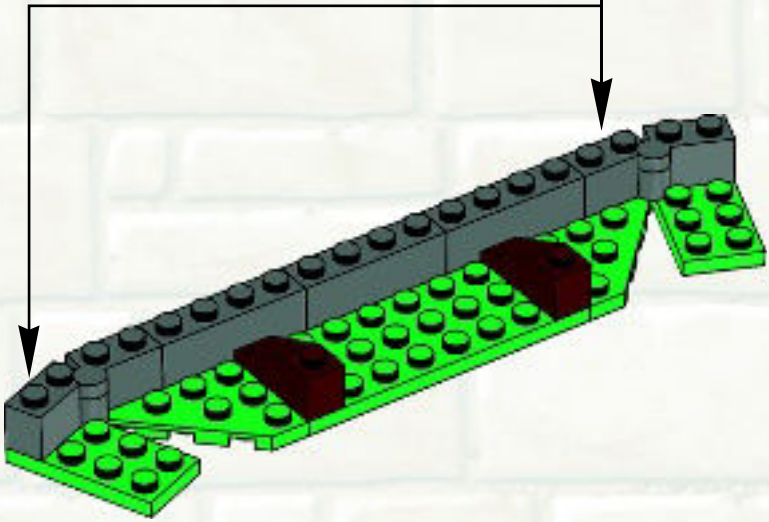
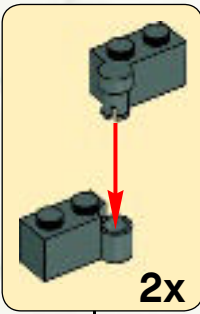

5

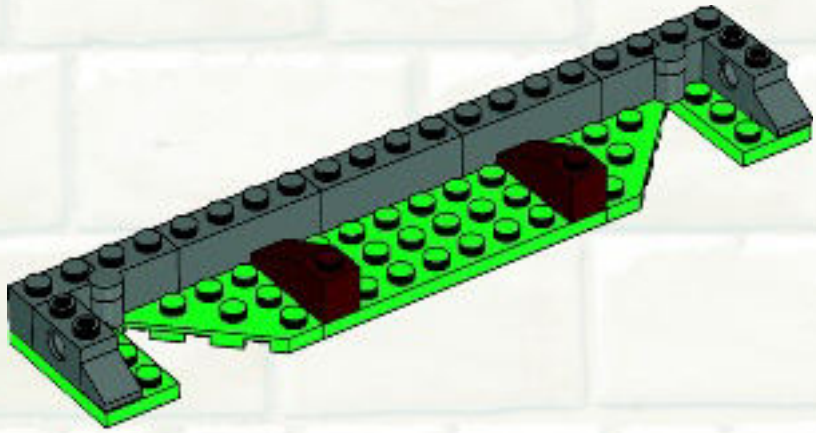



6

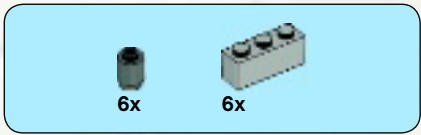
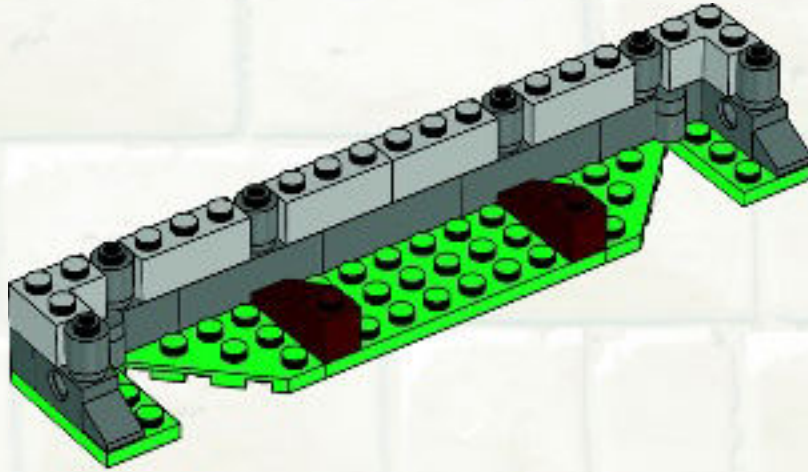

7

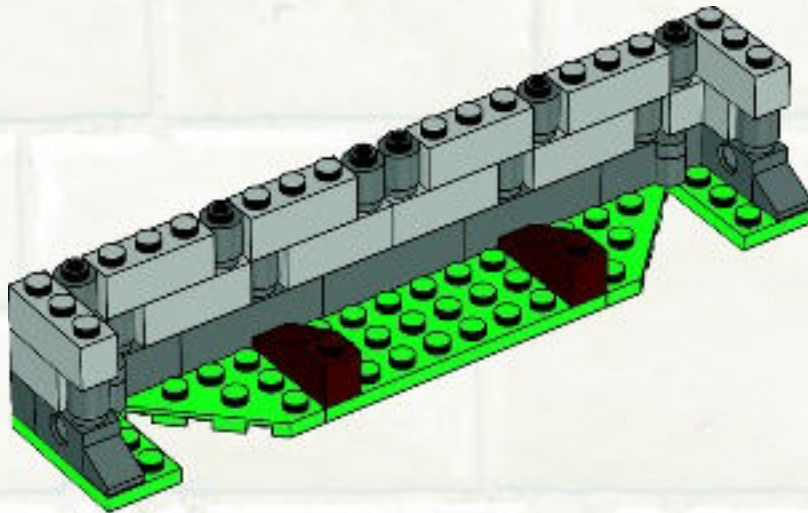



8

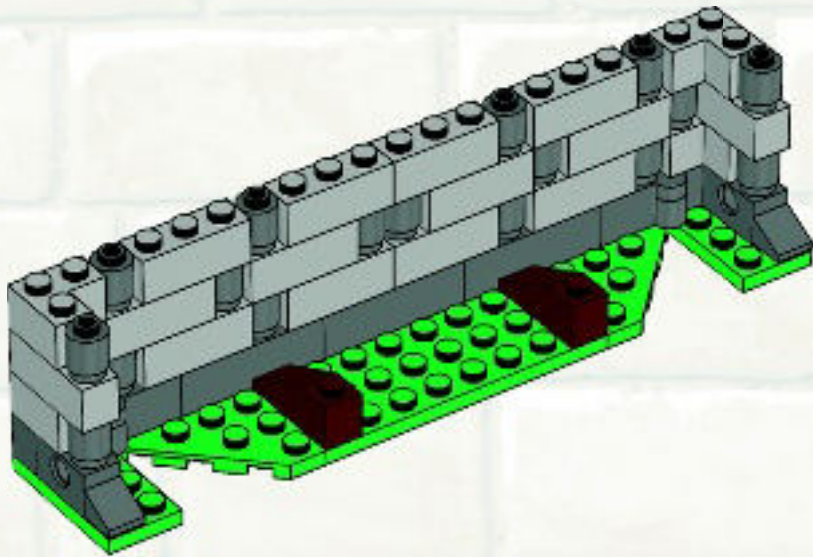

9

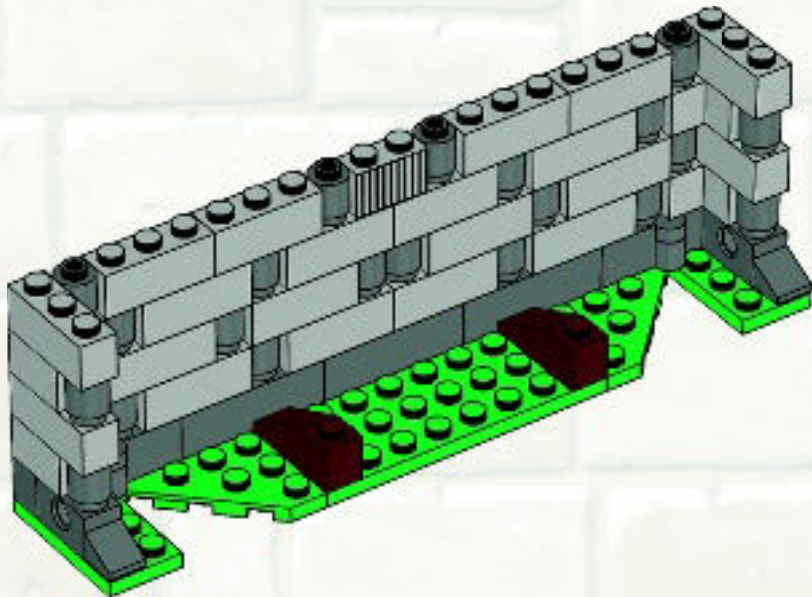

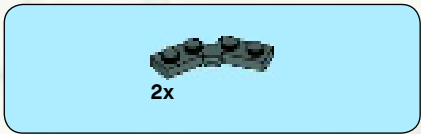

10

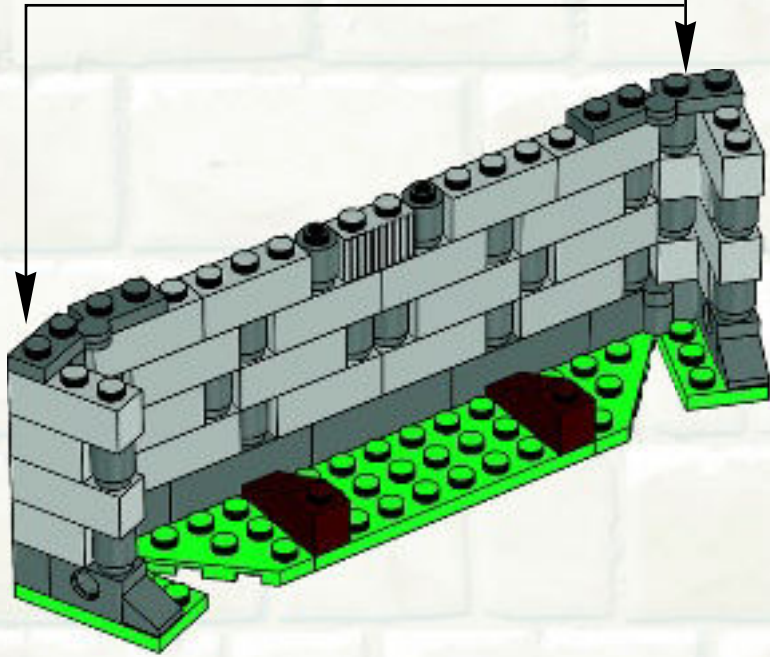
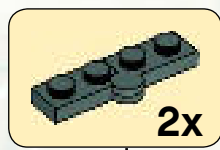

11

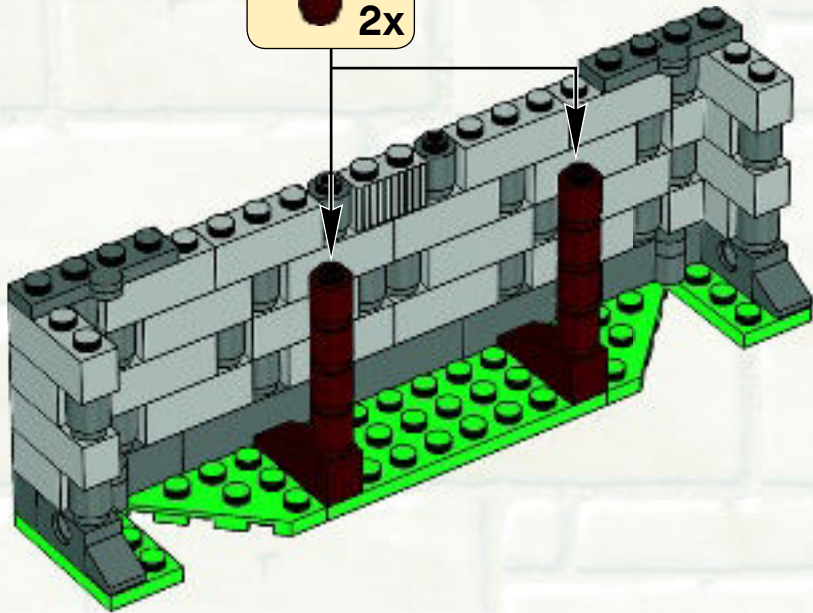
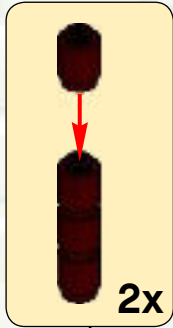

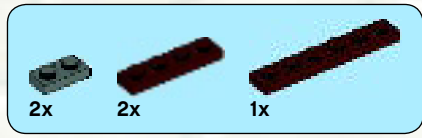

12

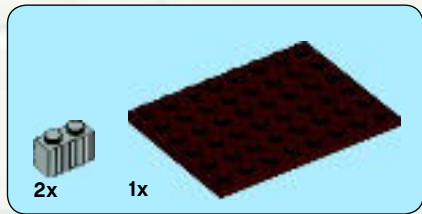
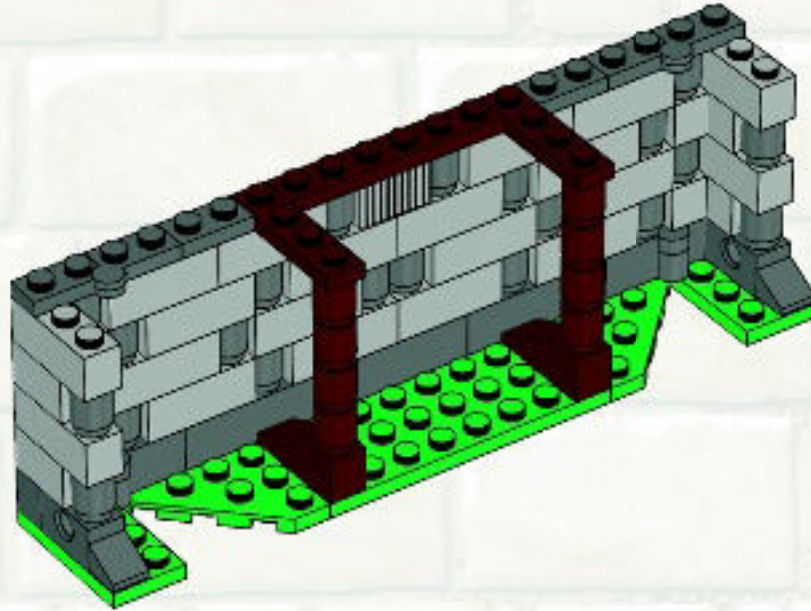

13

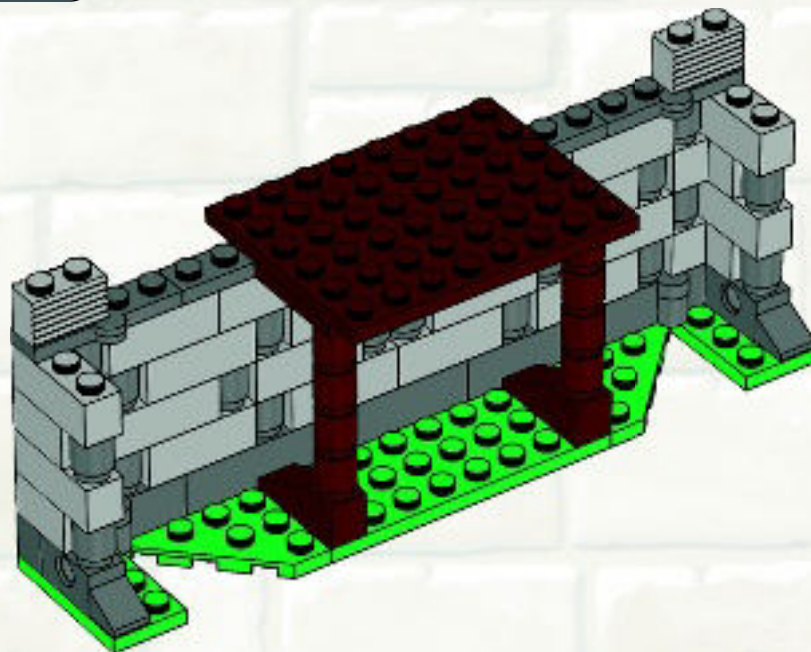

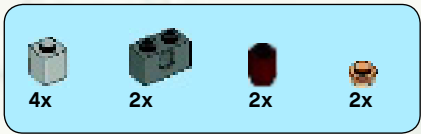

14

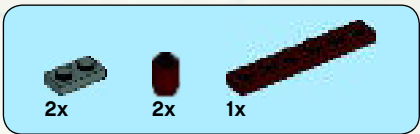
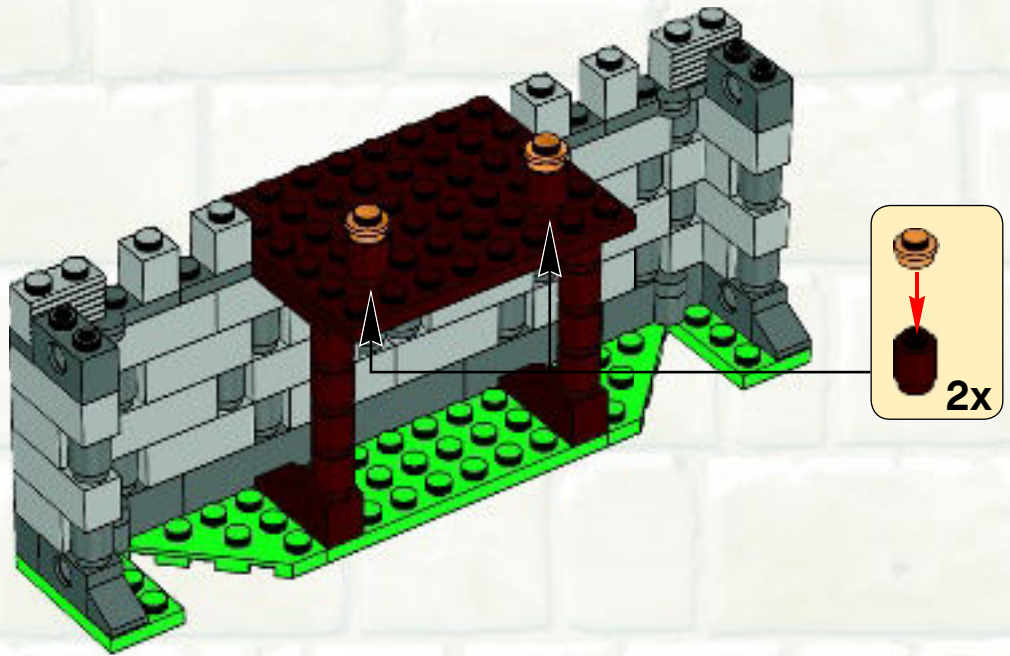

15

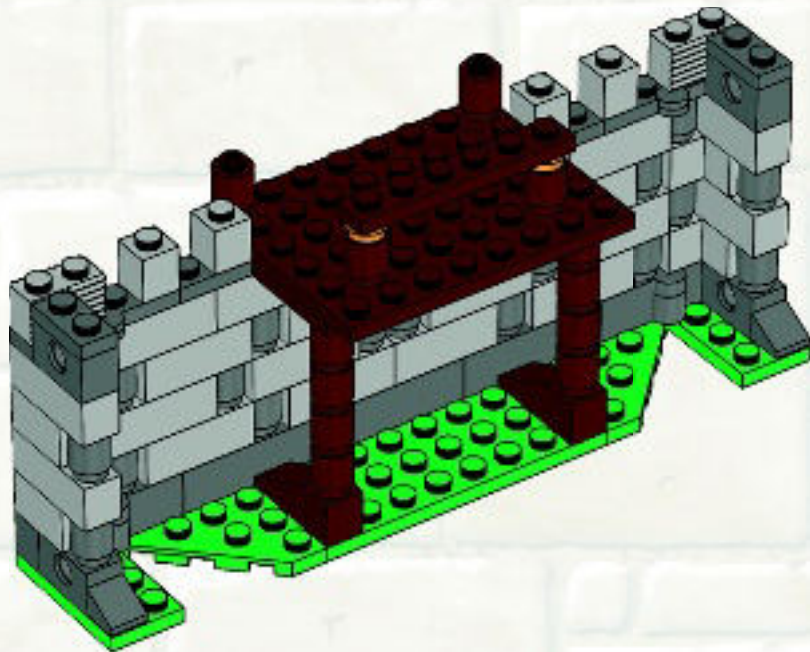



2x



7x

16

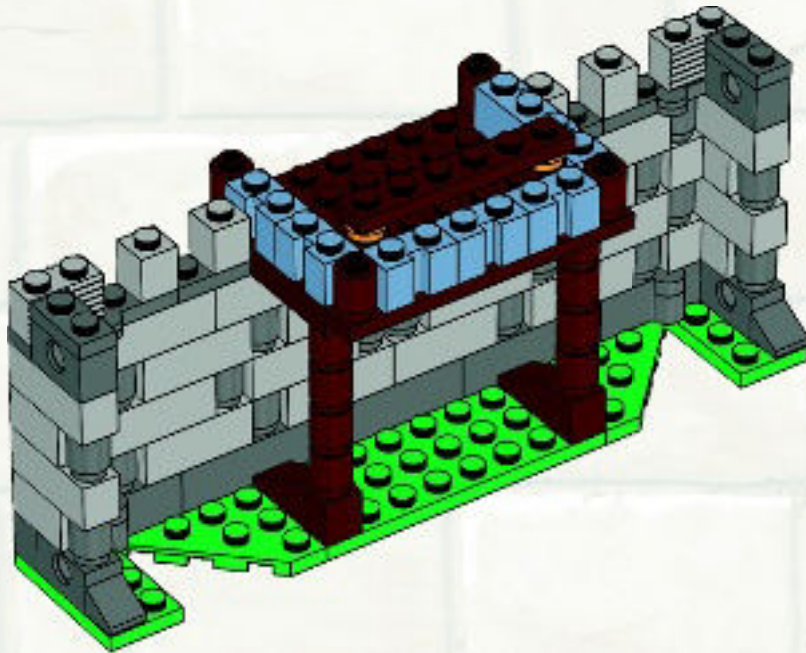

1x



2x



4x



2x



1x

17

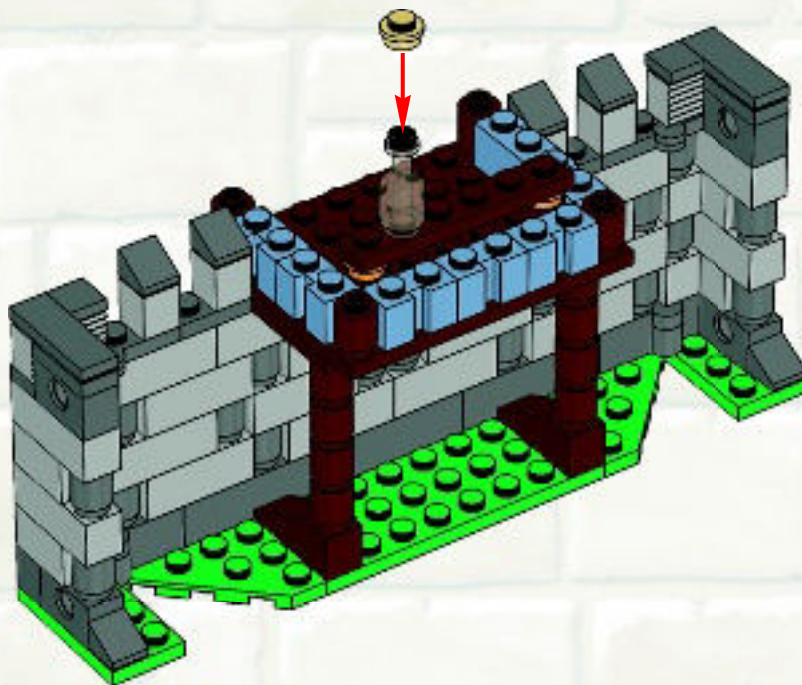

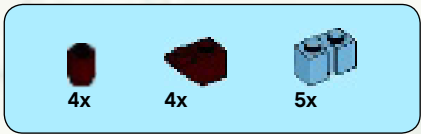

18

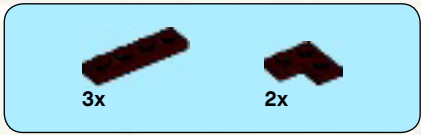
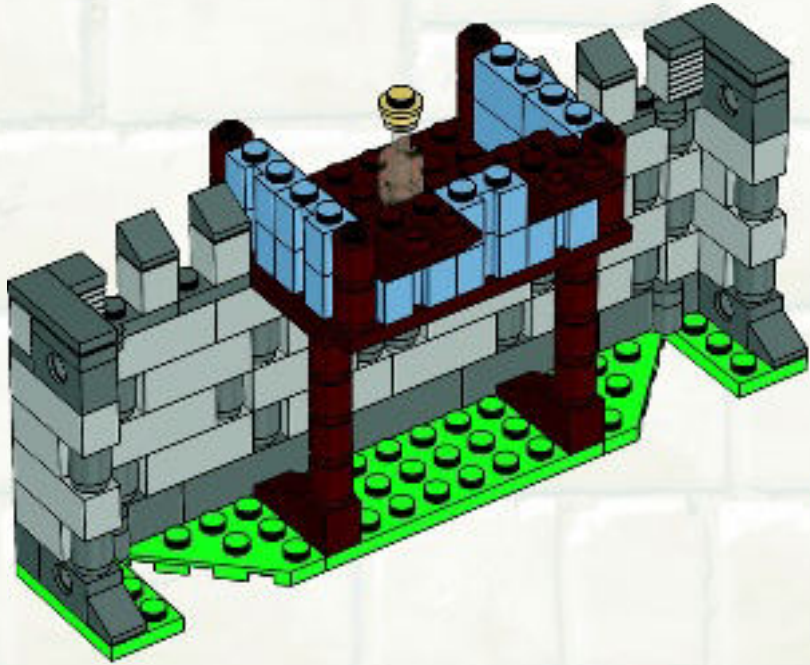

19

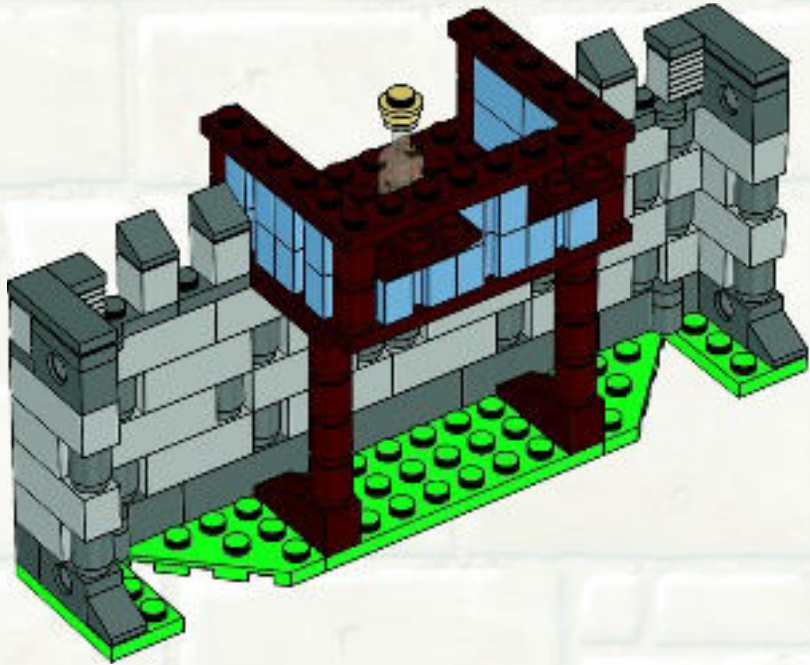

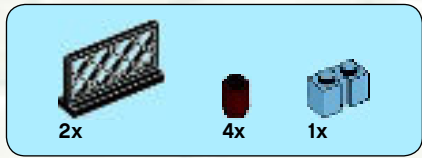

20

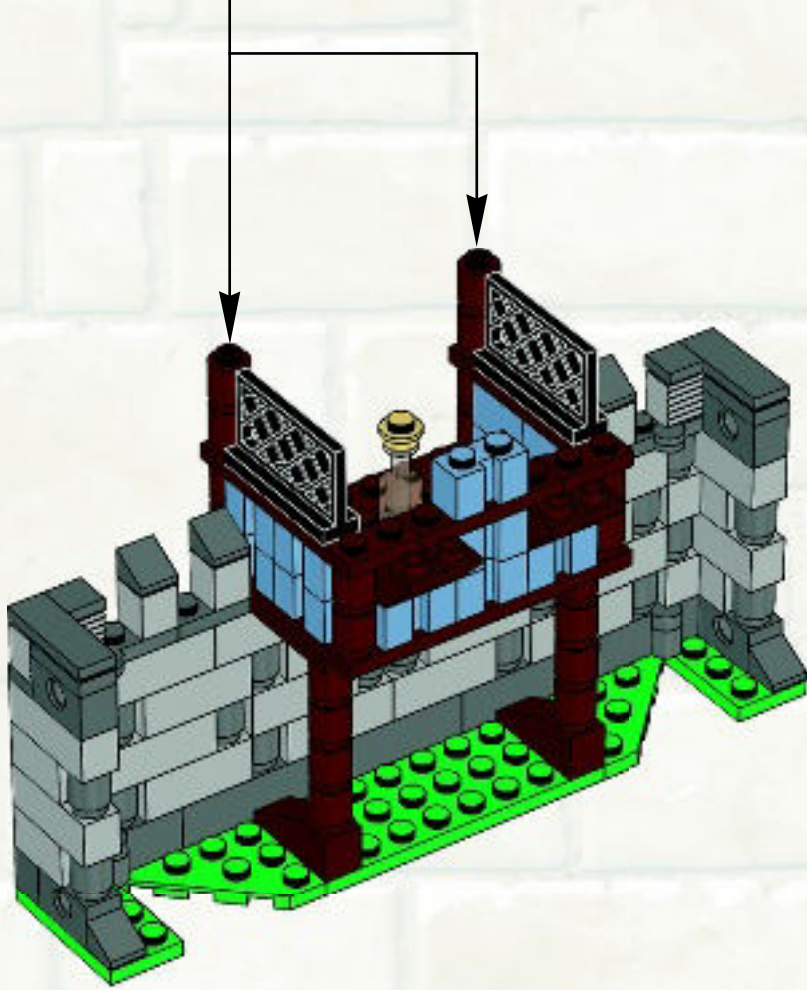
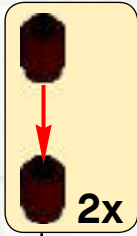

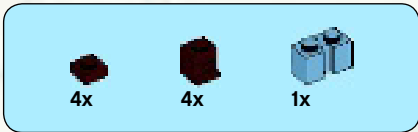

21

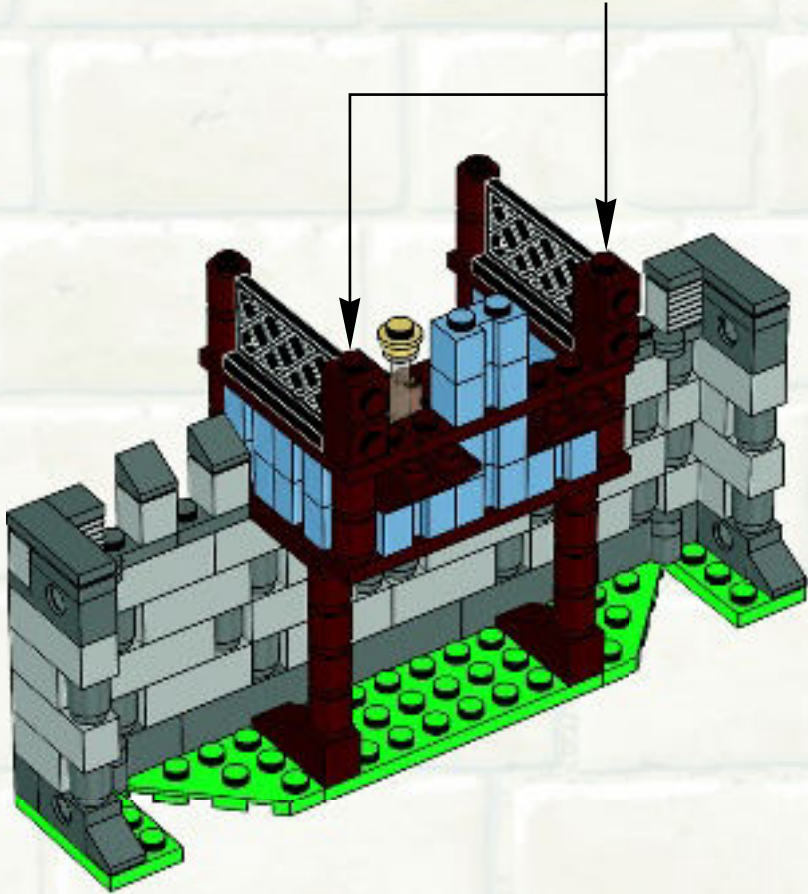
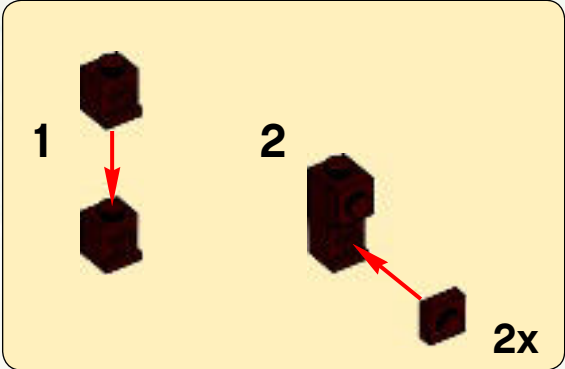



3x

22

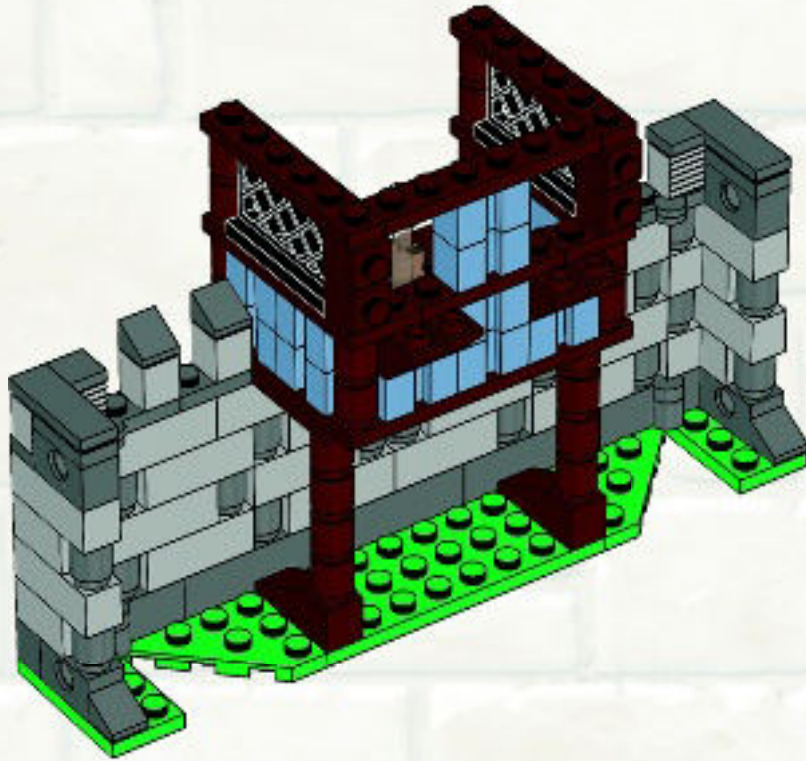

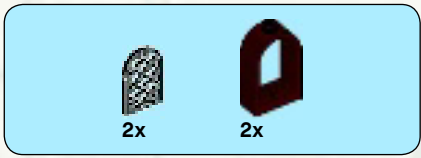

23

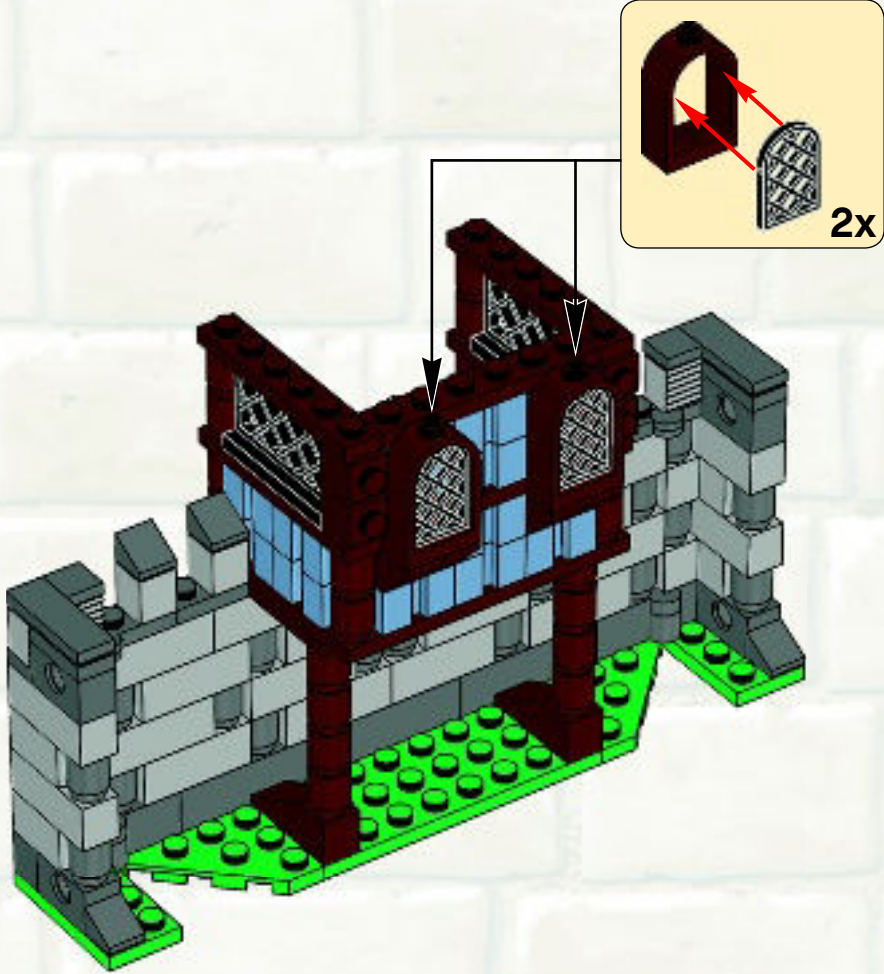

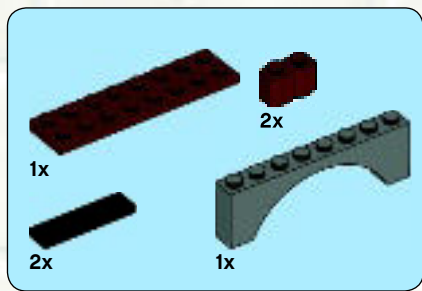

24

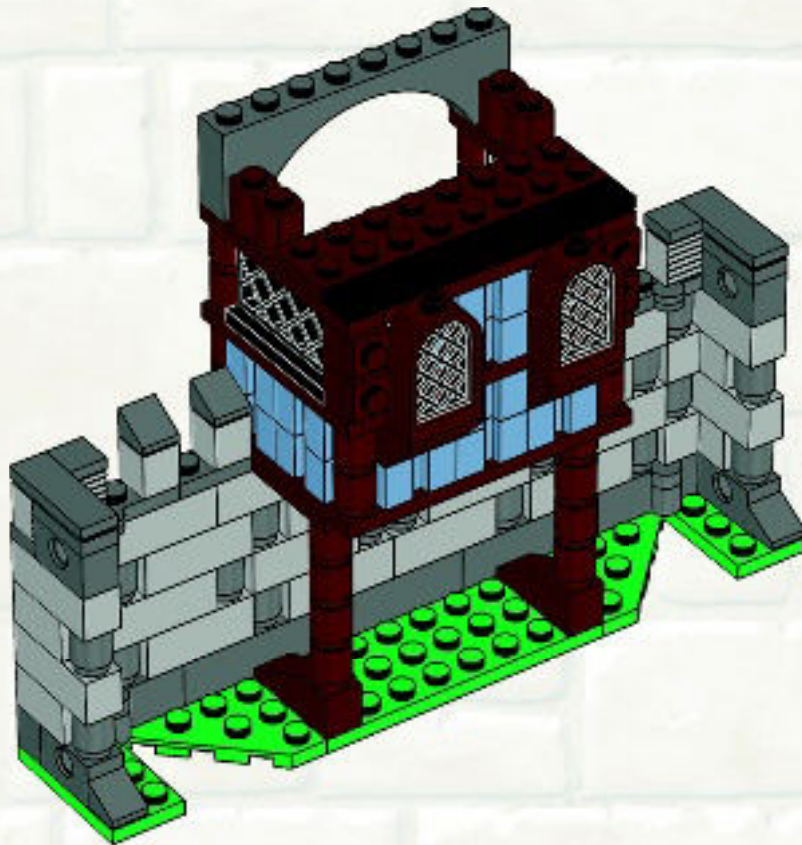



2x



4x

25

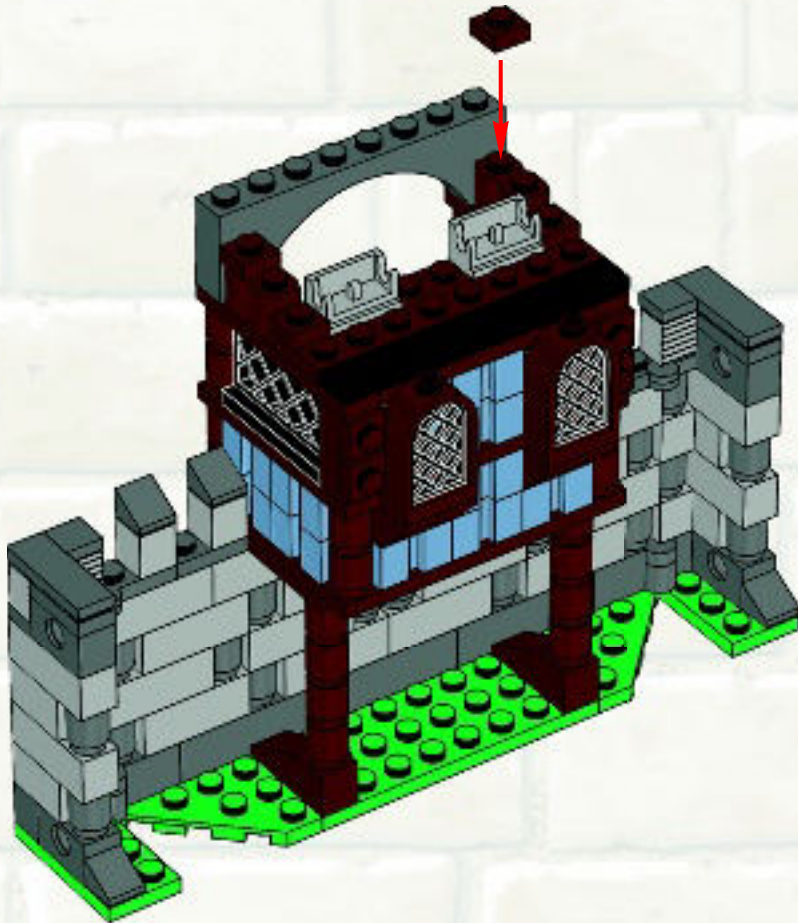



8x



2x

26

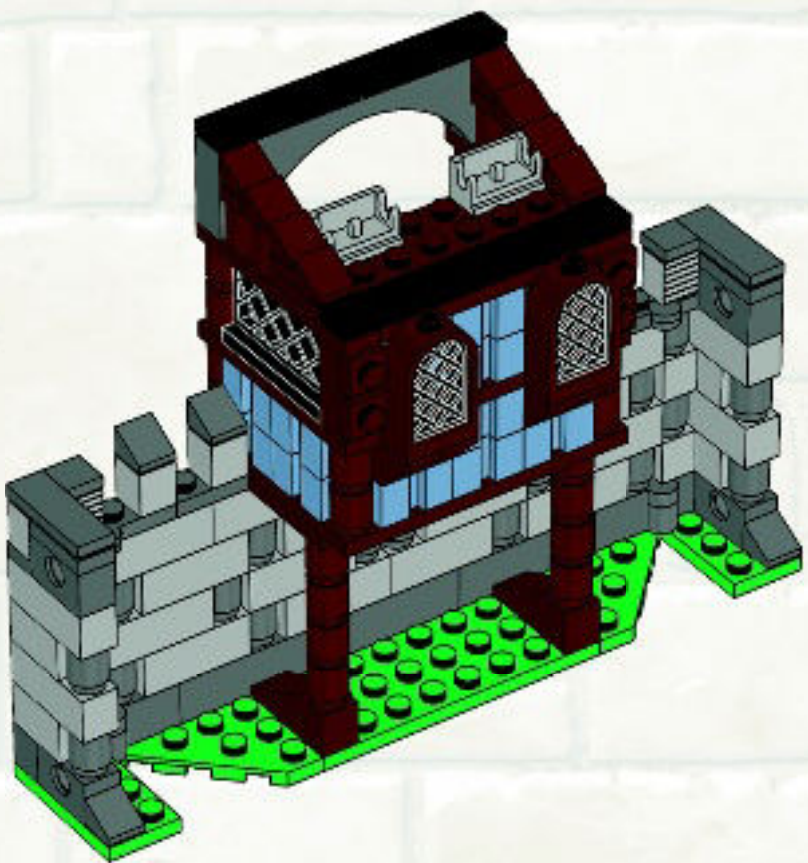

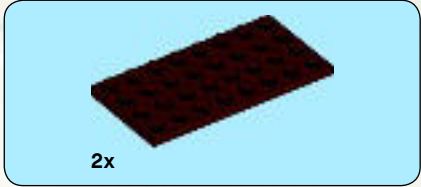

1

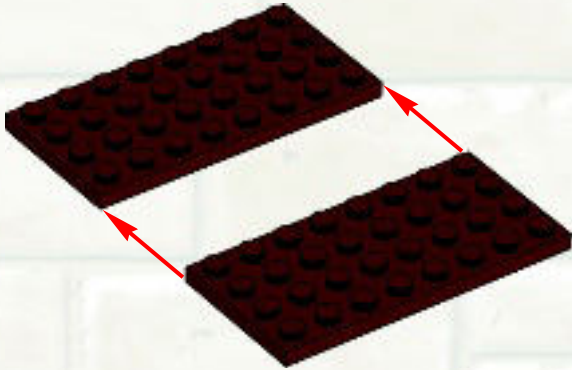

2



3

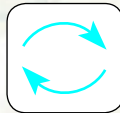

4

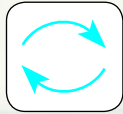

27

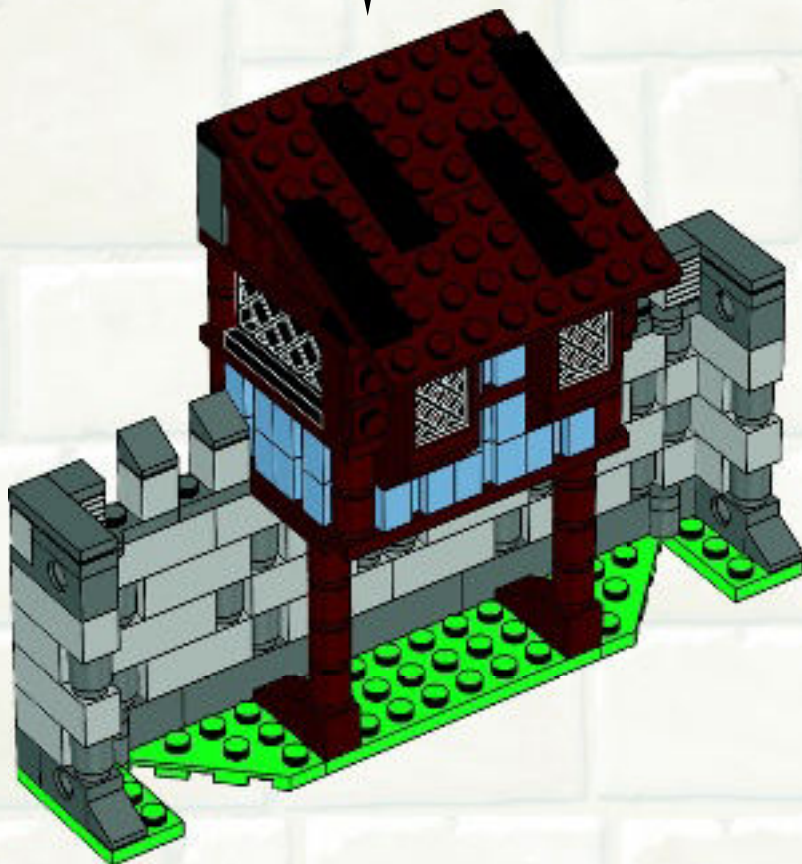

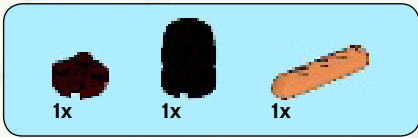

28



5

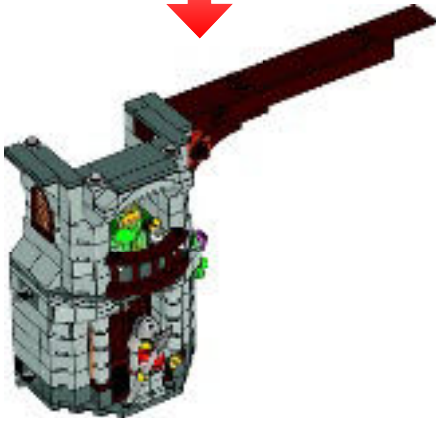

1x

1x

1

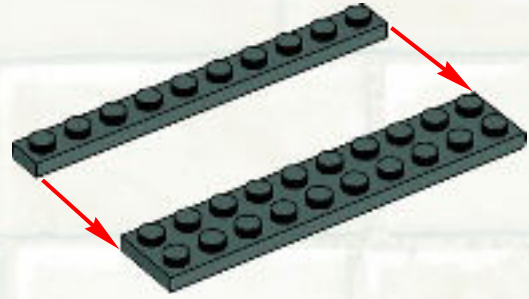

2x

2x

5x

2

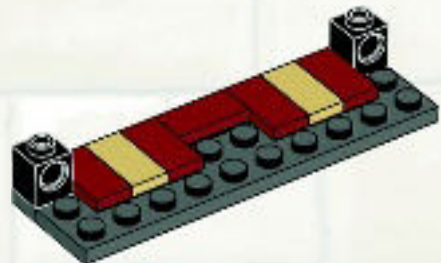

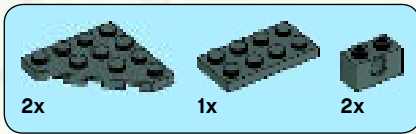

3

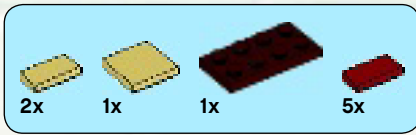
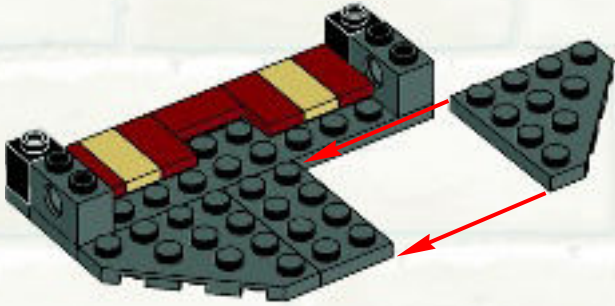

4

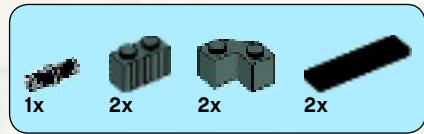
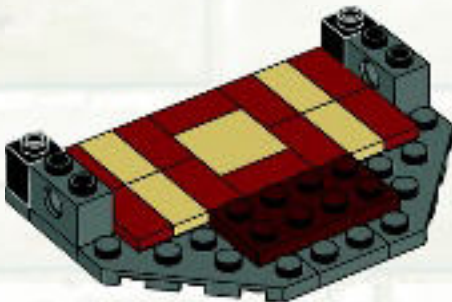

5

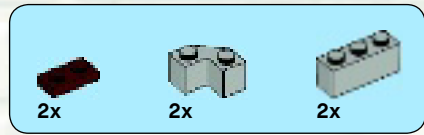
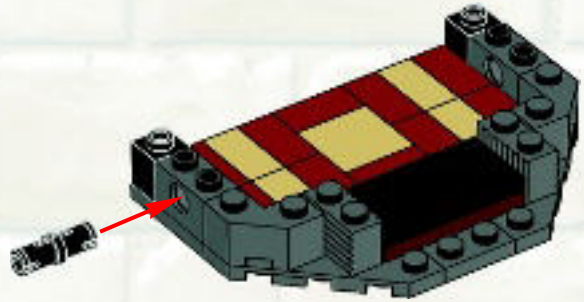

6

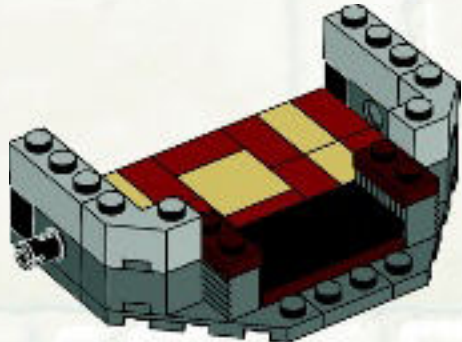

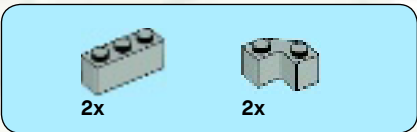

7

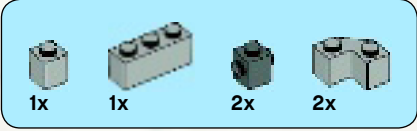
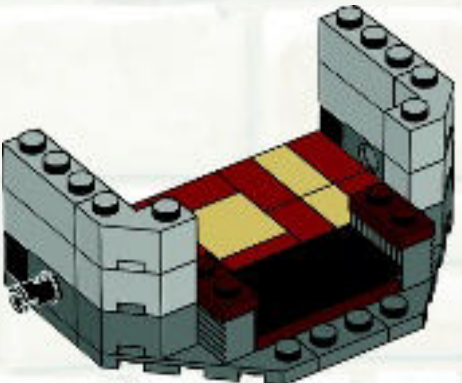

8

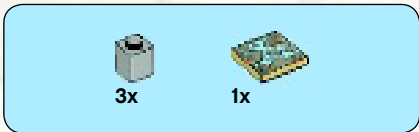
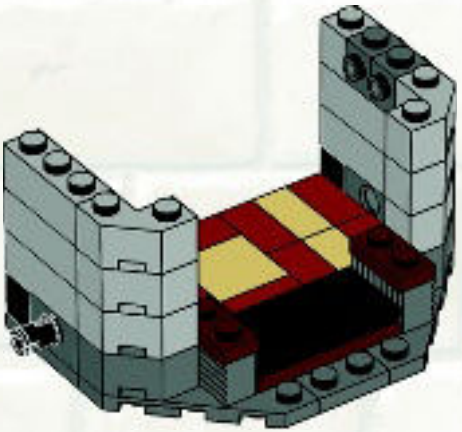

9

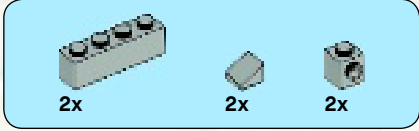
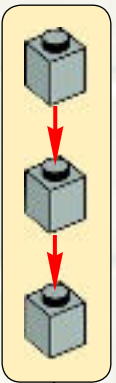
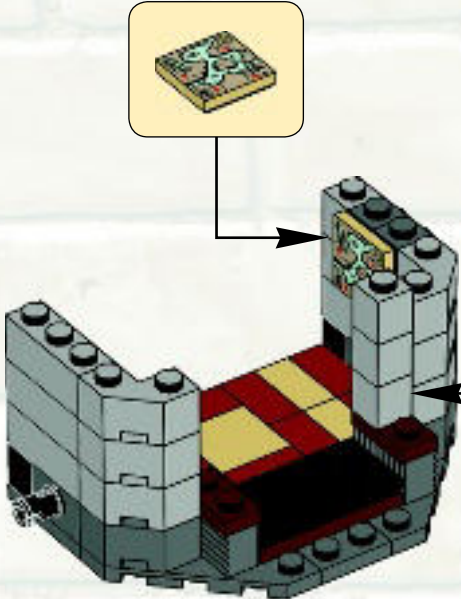

10

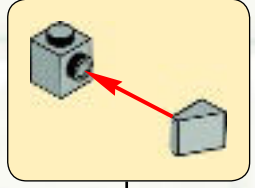
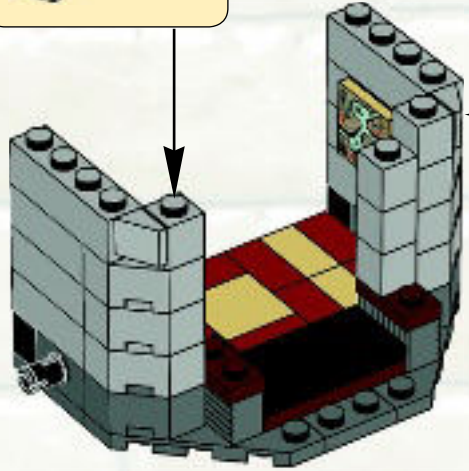
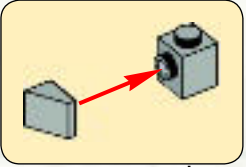

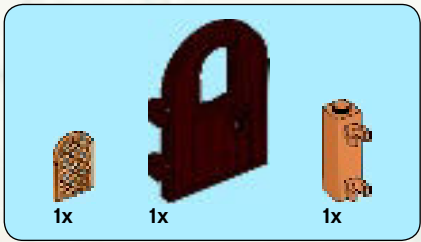

11

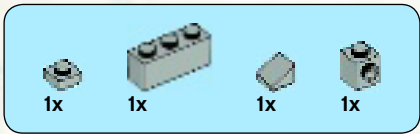
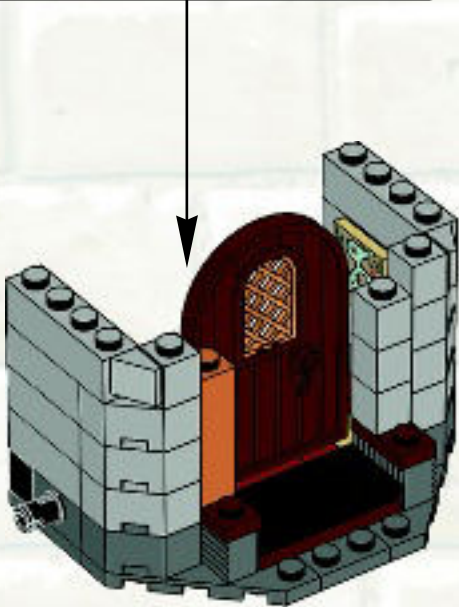
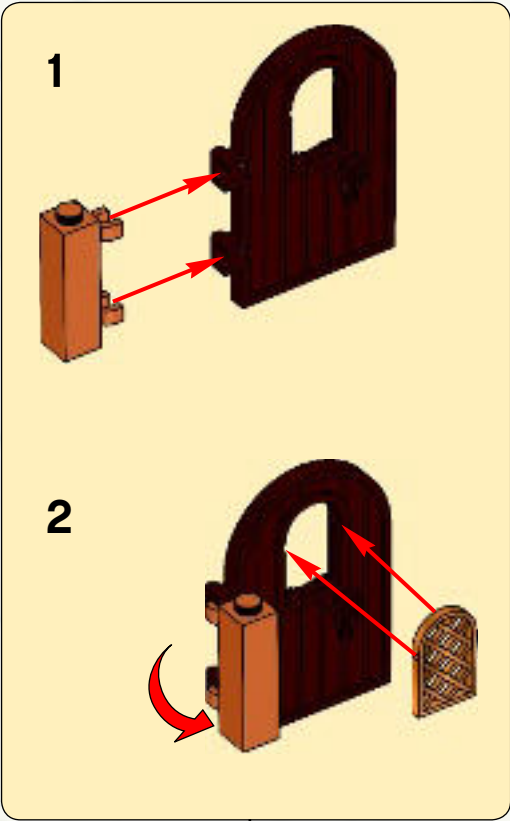

12

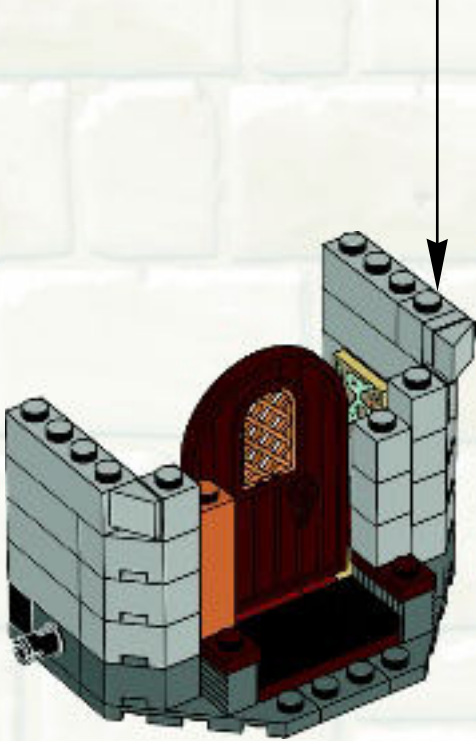
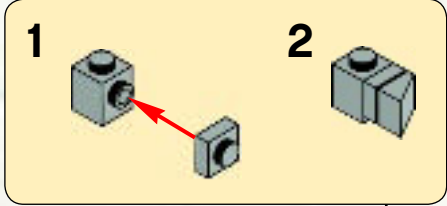

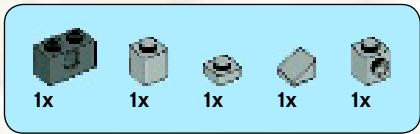

13

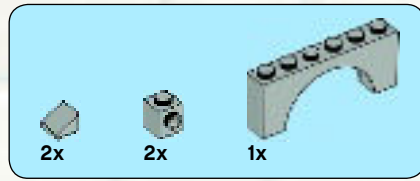
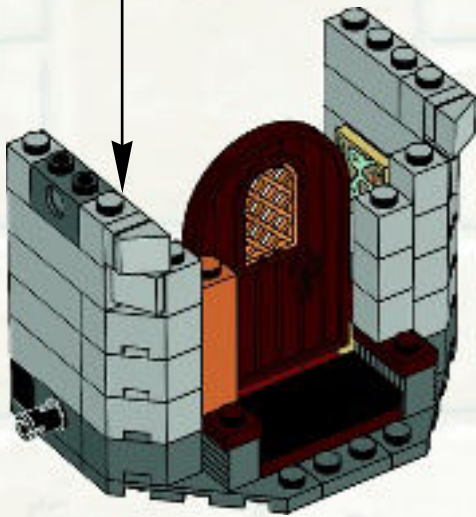
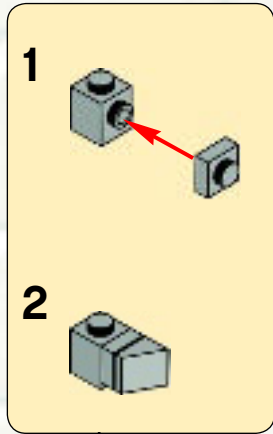

14

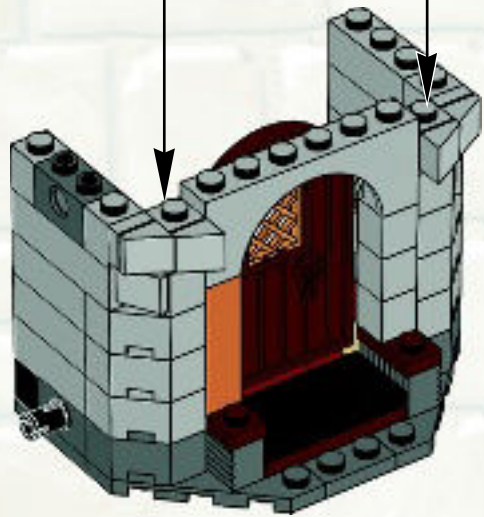
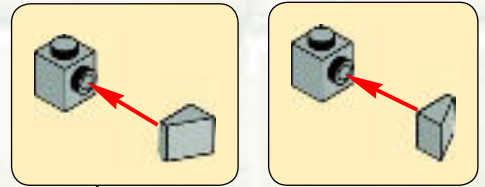



8x

15

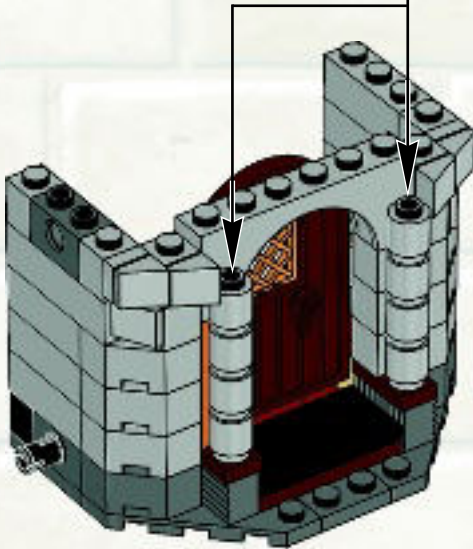
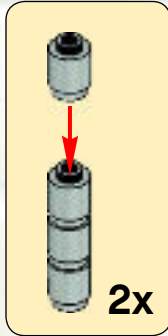

2x



2x



1x

16

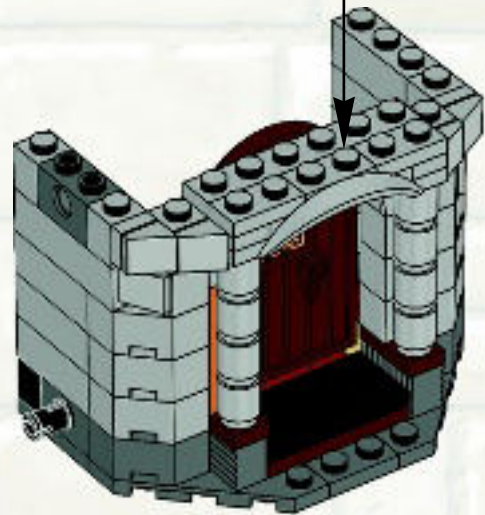
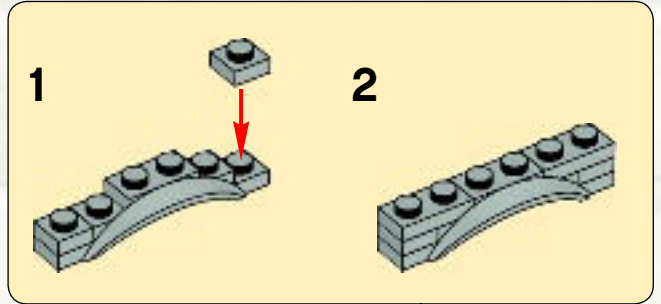

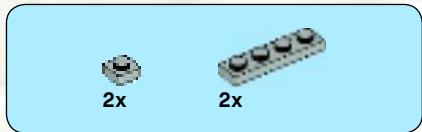

17

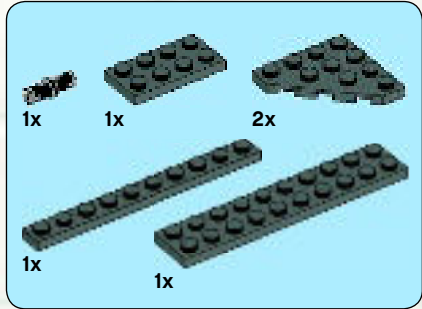
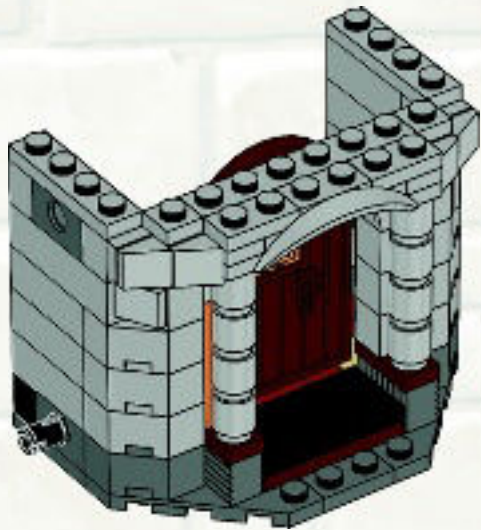

18

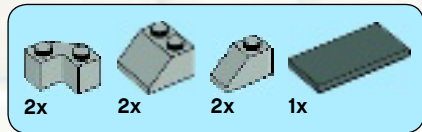
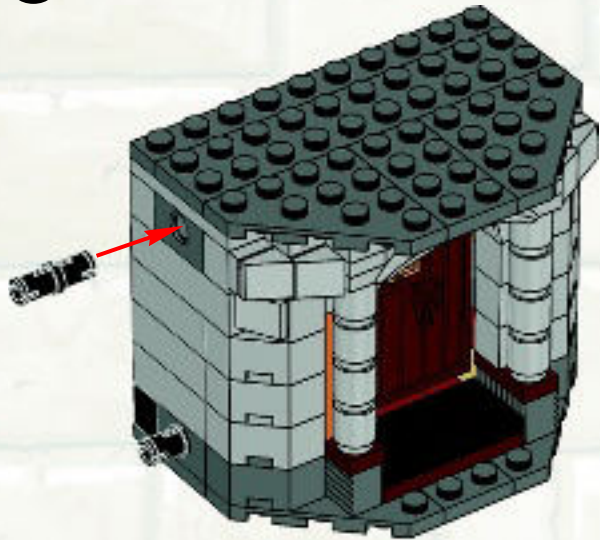

19

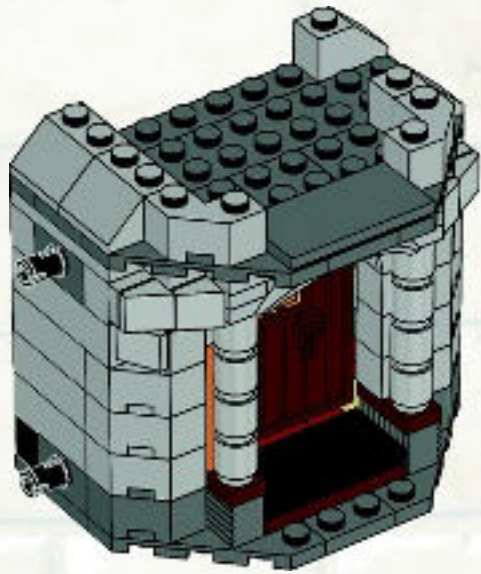

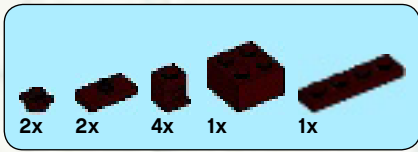

20

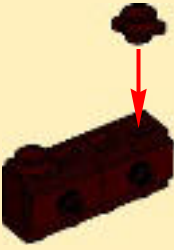
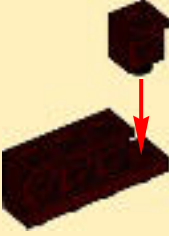
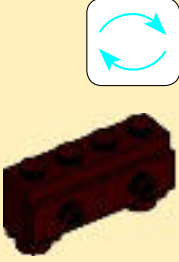
<p>1</p> 	<p>3</p> 
<p>2</p> 	<p>4</p> 

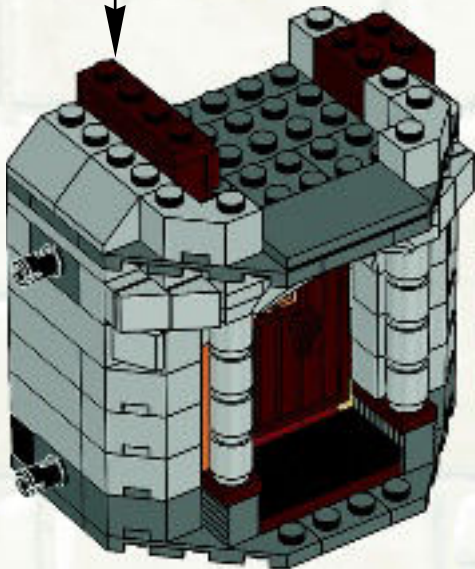

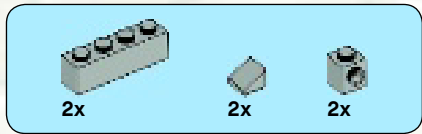

21

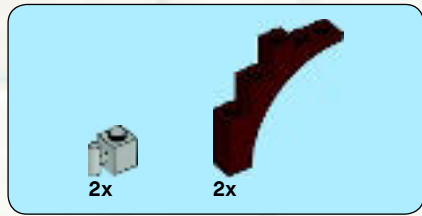
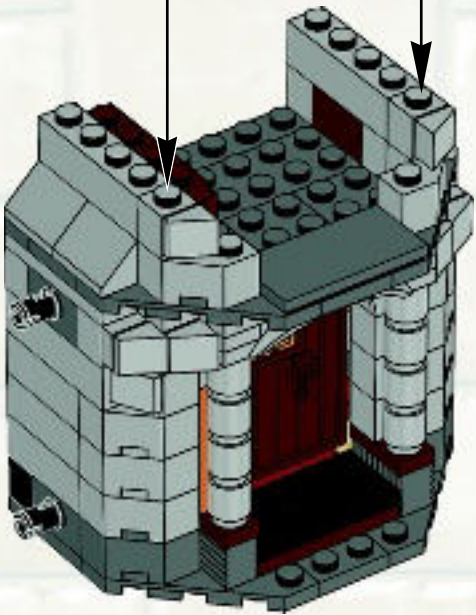
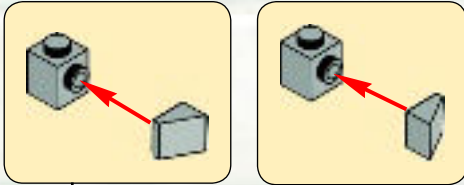

22



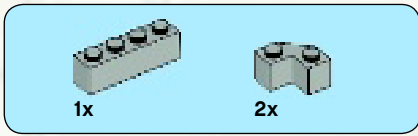

23

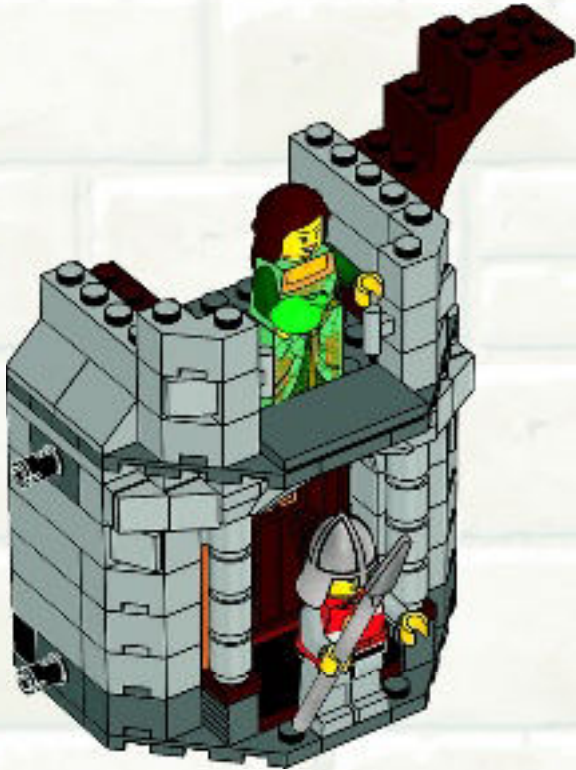

24

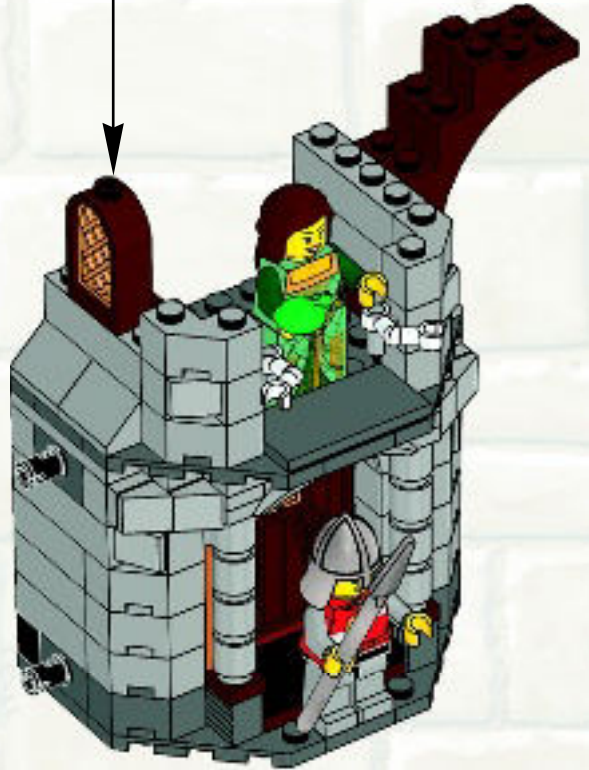

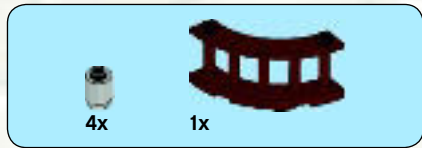

25

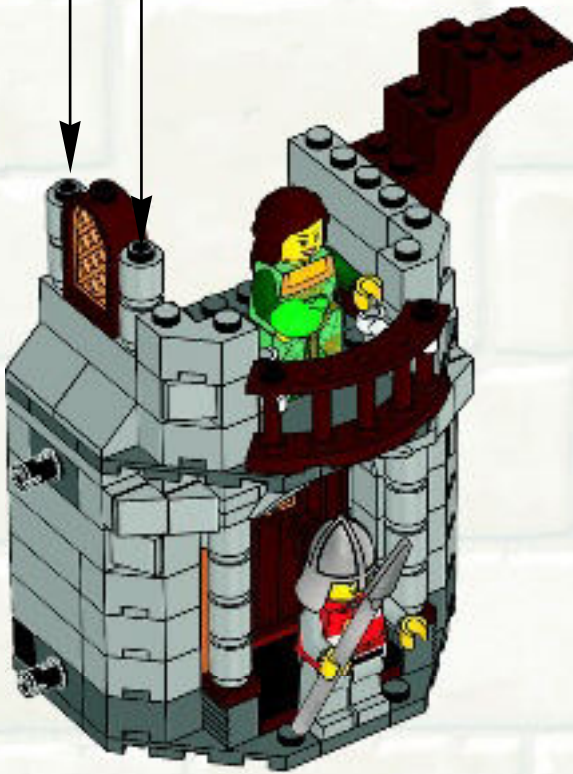
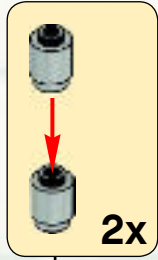

26

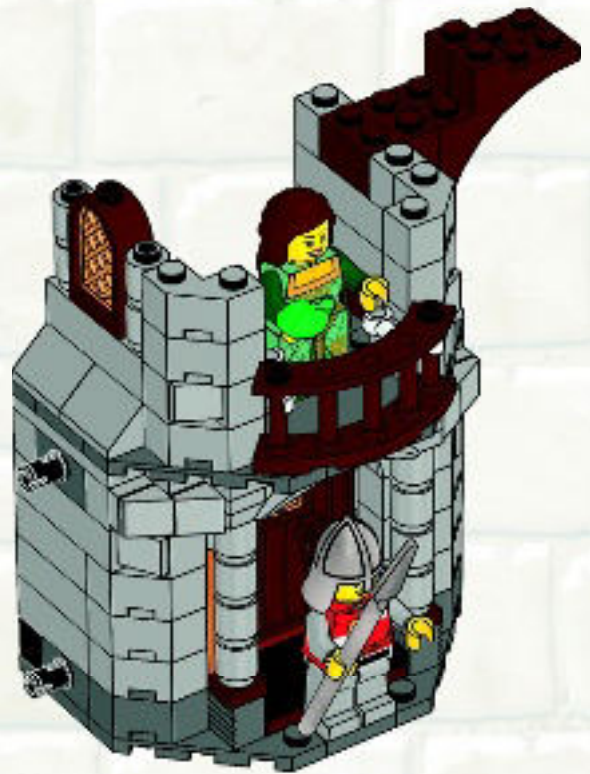

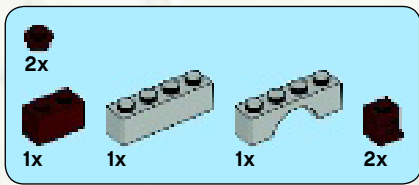

27

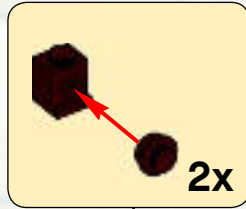

28

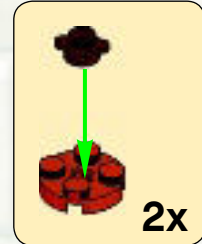

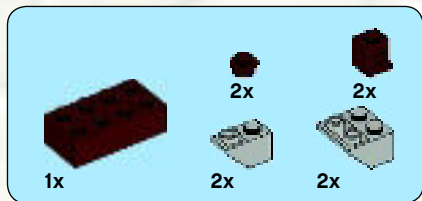

29

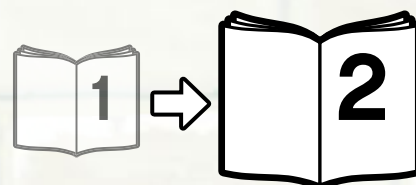

Kingdoms



LEGO

10223

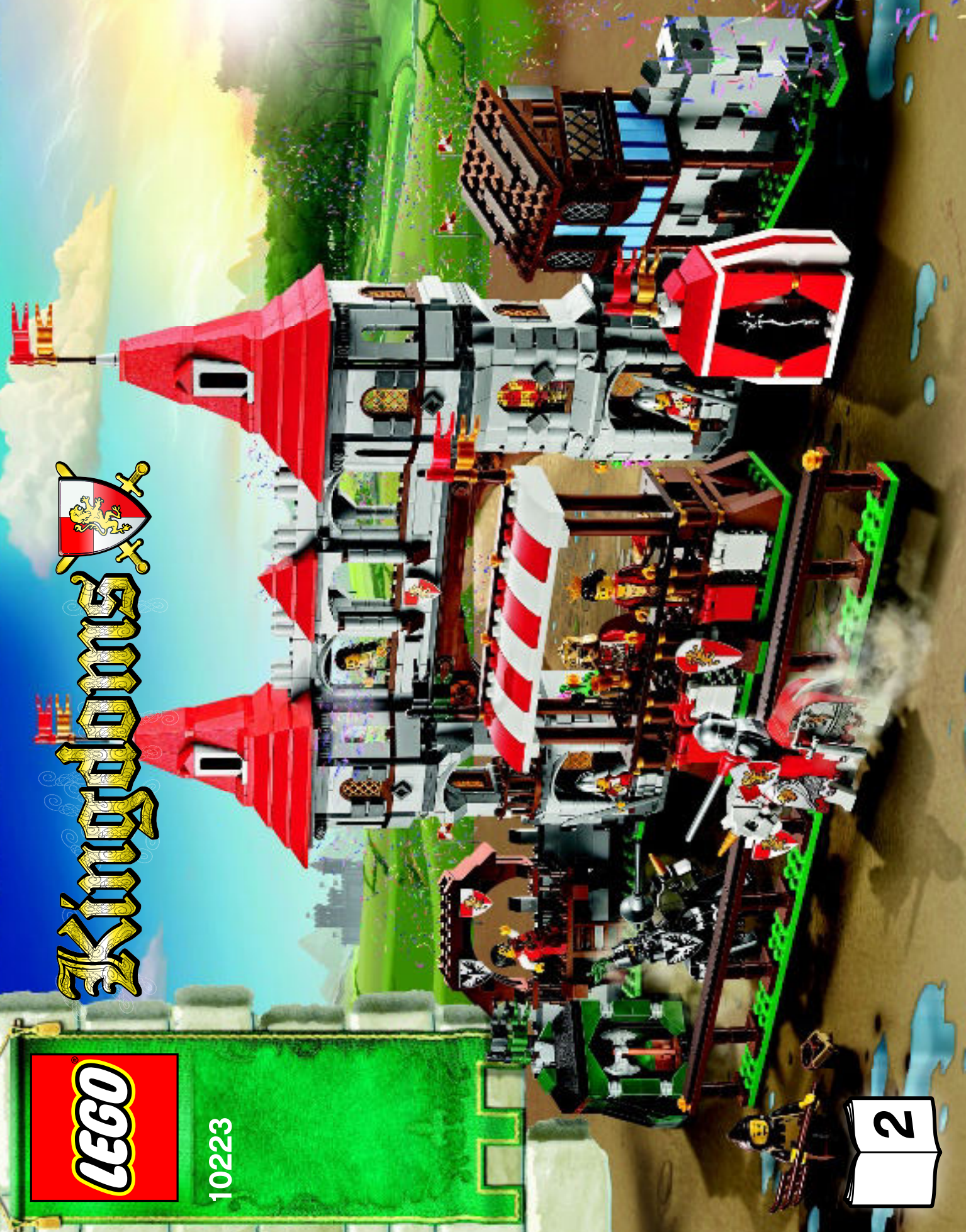



6



7

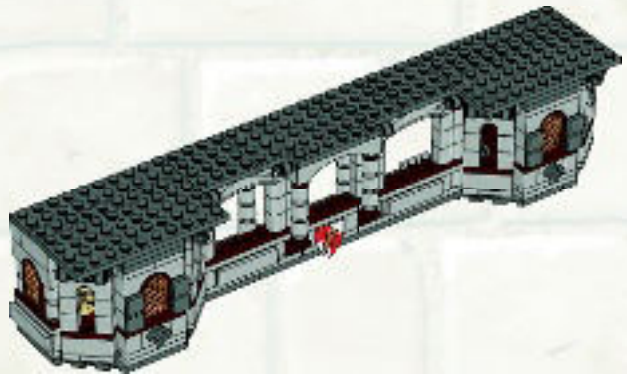

8

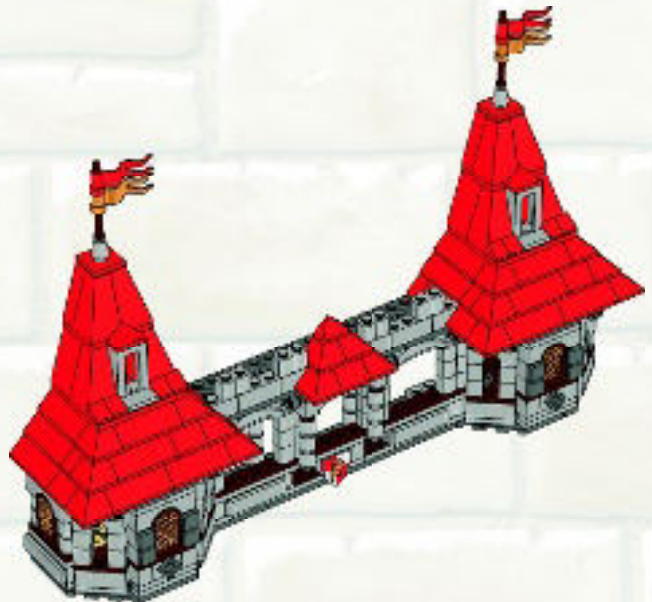
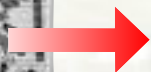

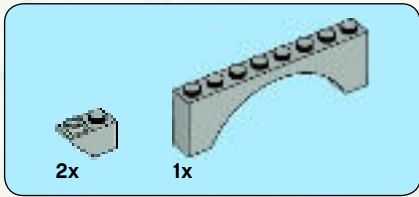

30



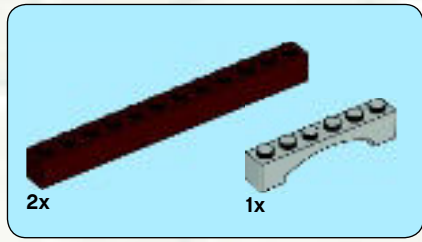

31



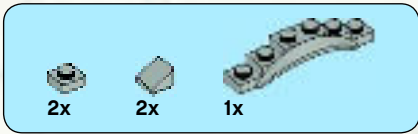

32

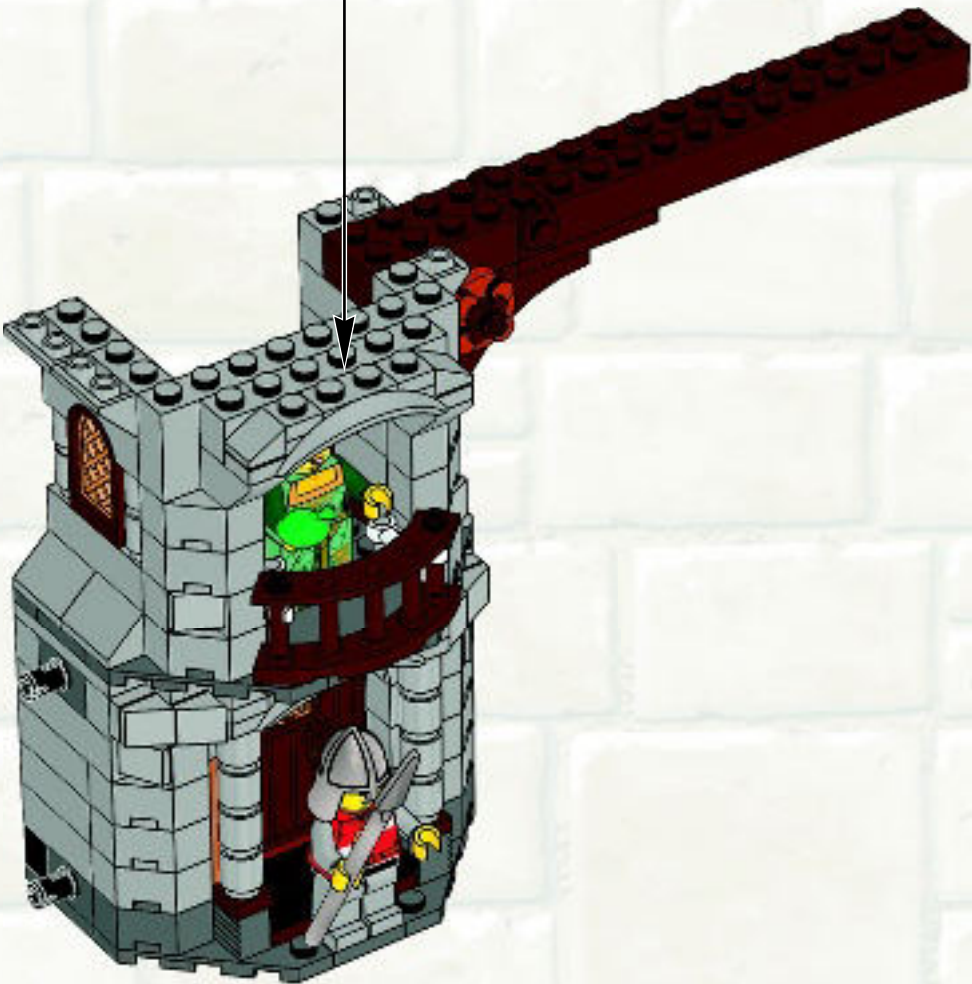
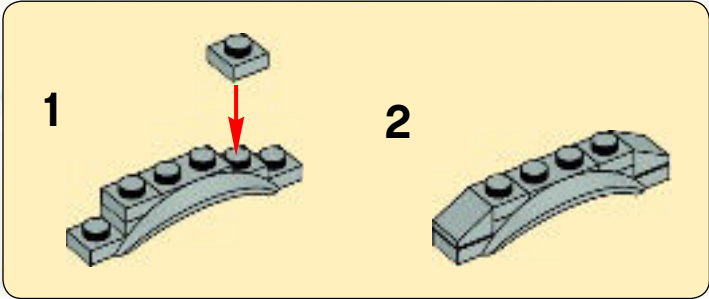

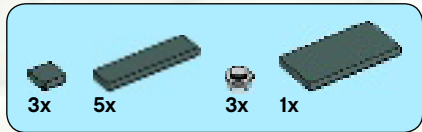

33



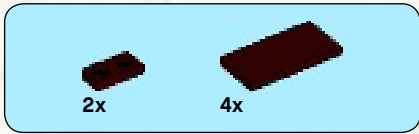

34

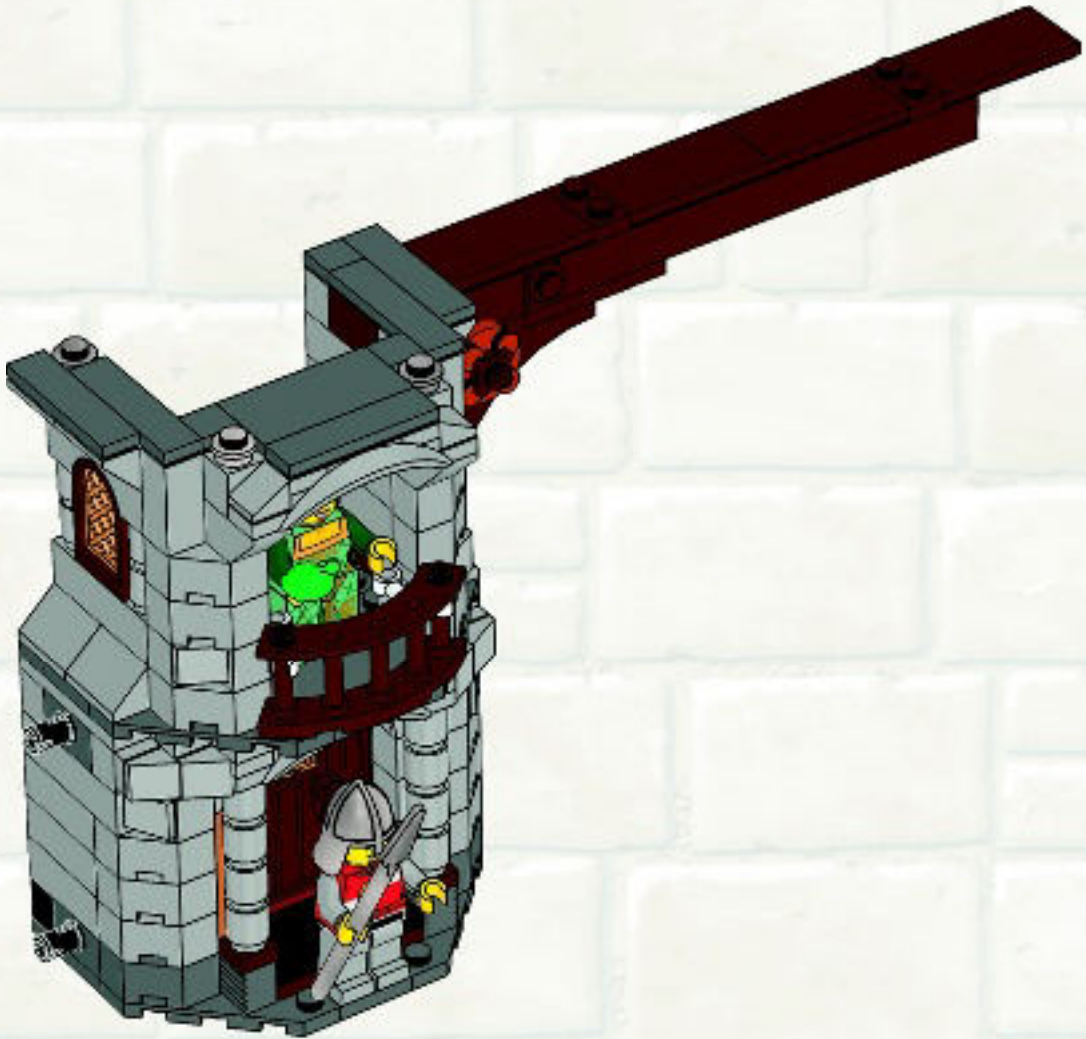

2x  2x  2x 

35

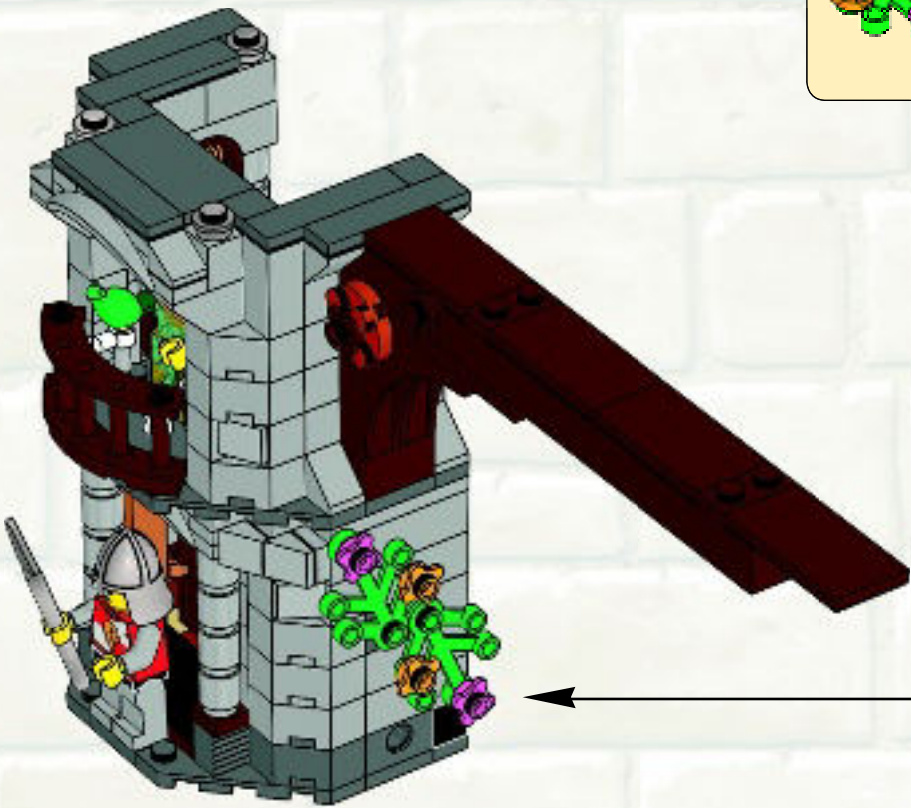

 2x

36

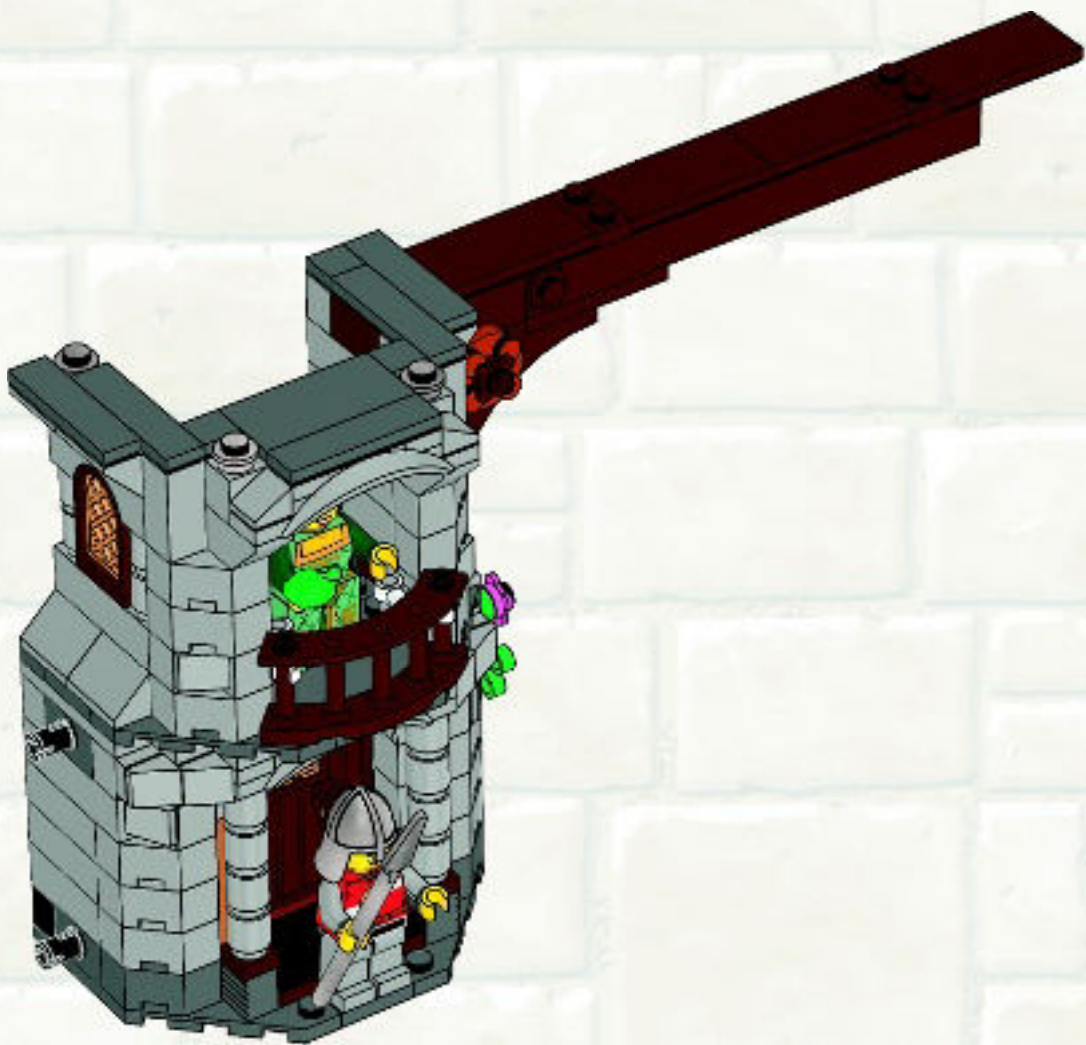

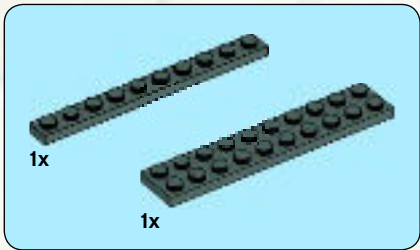
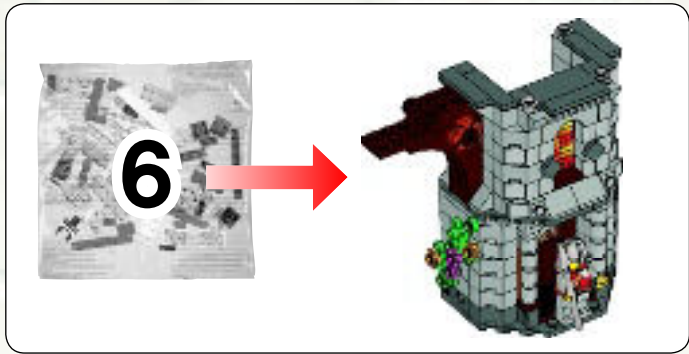

1

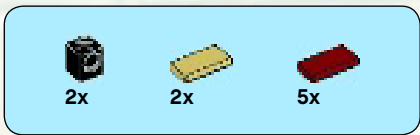
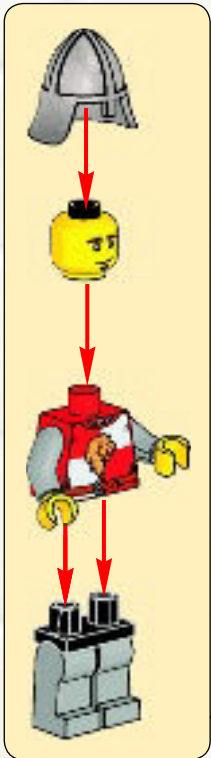
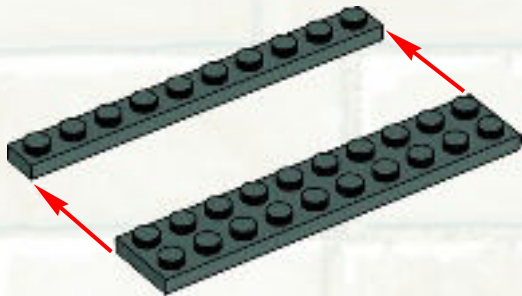

2

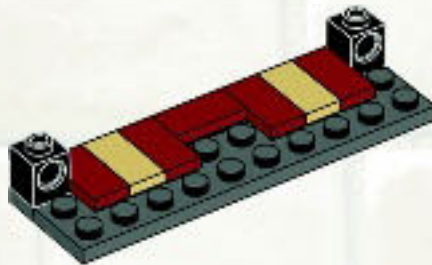

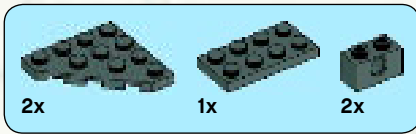

3

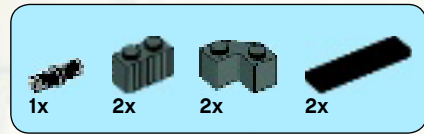
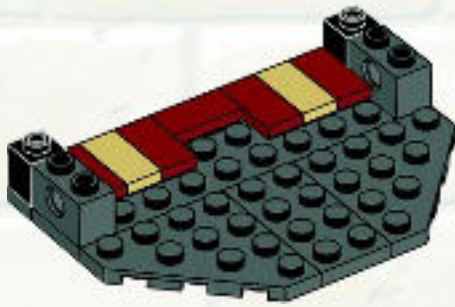

5

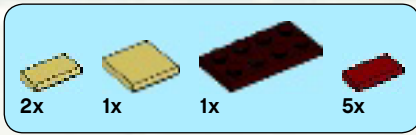
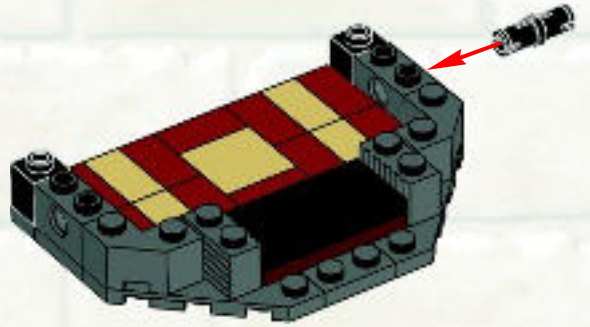

4

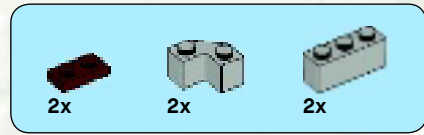
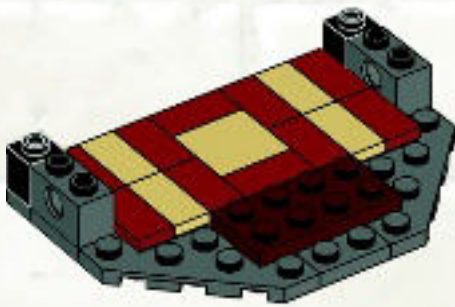

6

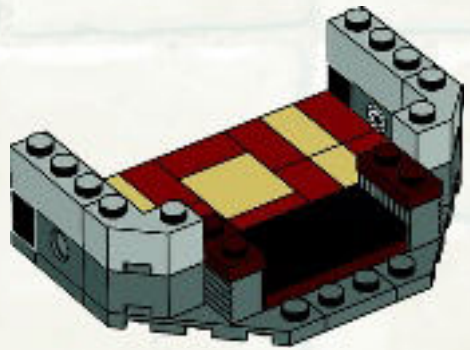

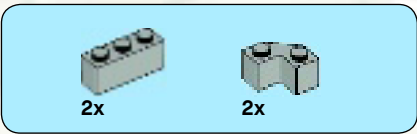

7

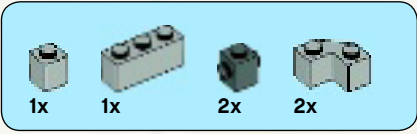
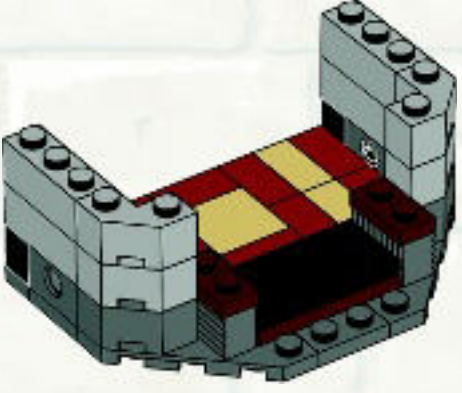

8

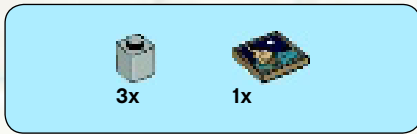
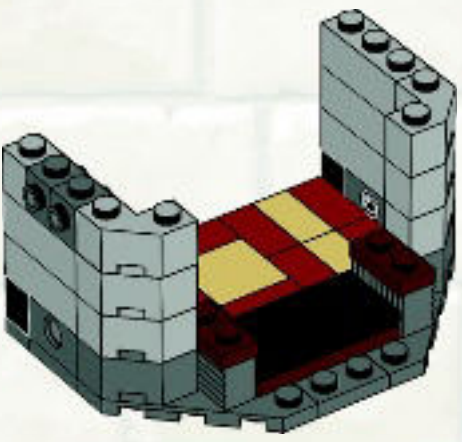

9

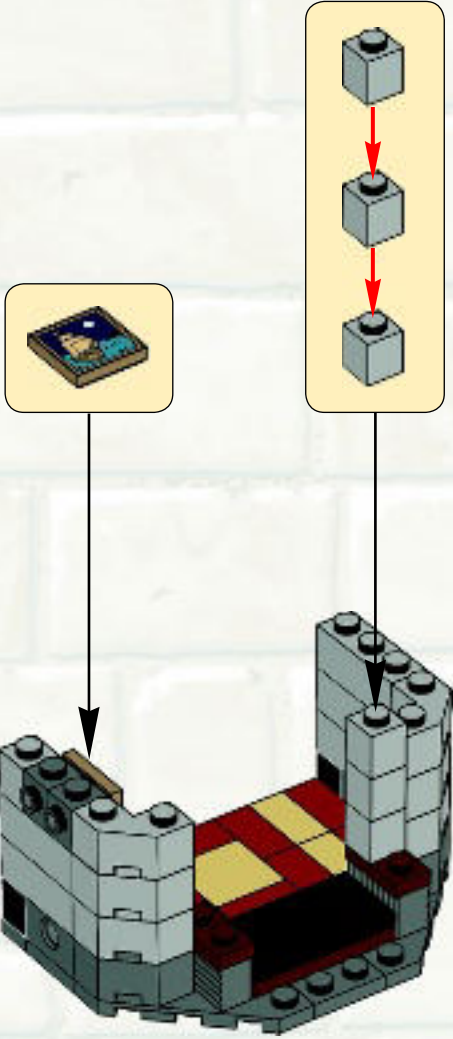

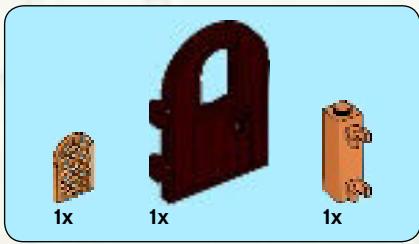

10

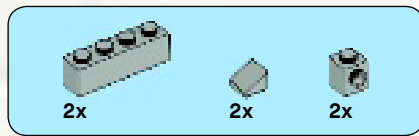
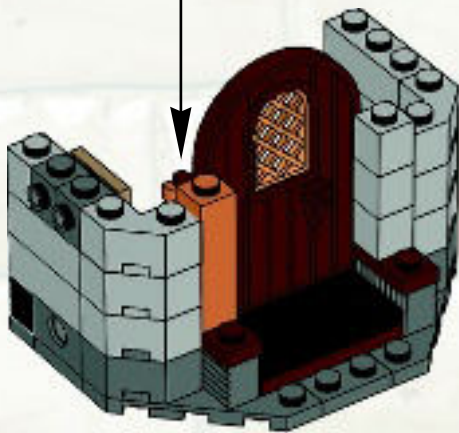
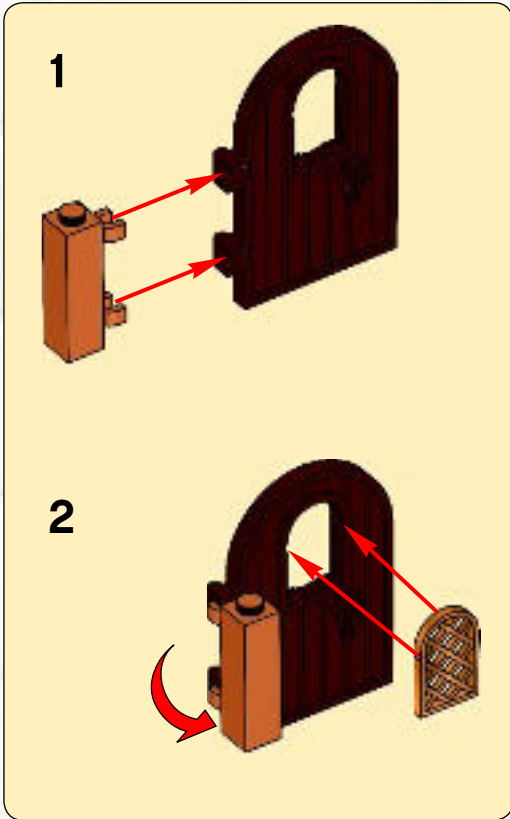

11

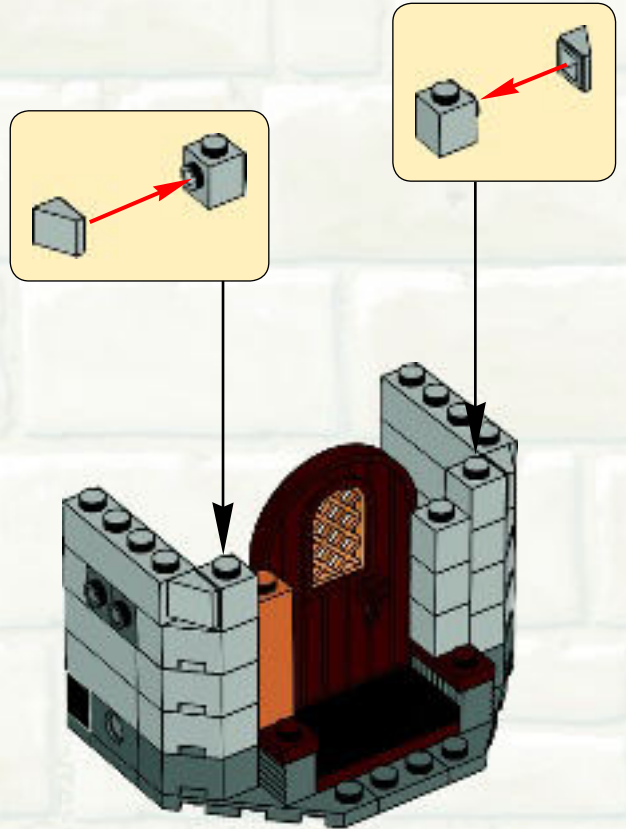

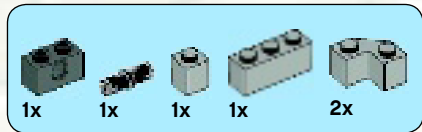

12

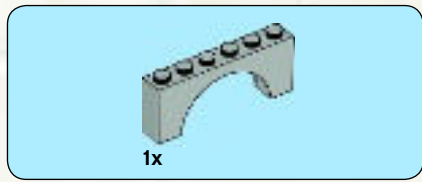
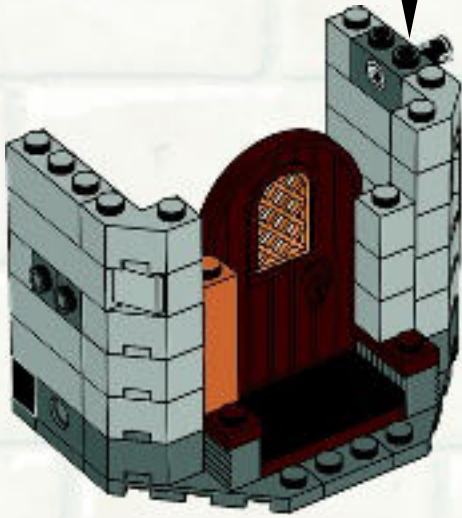
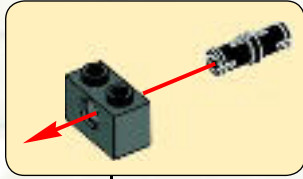

13

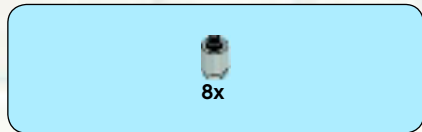
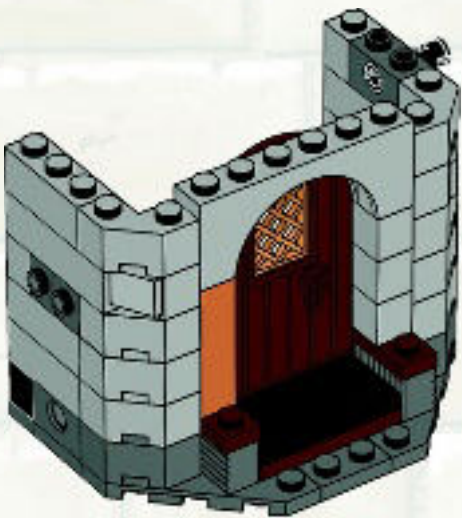

14

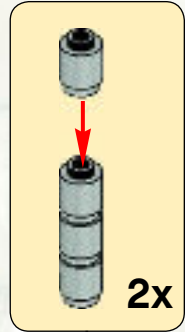

2x

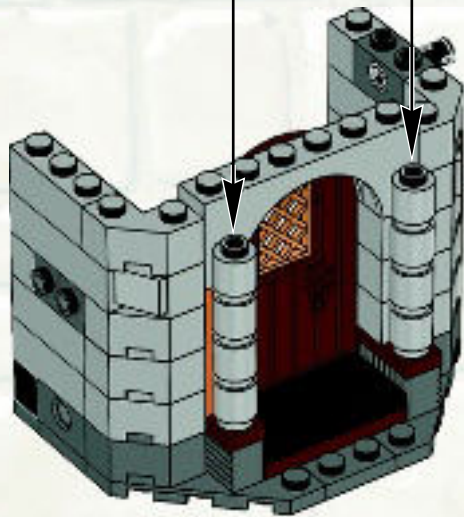

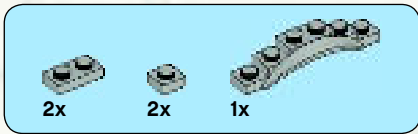

15

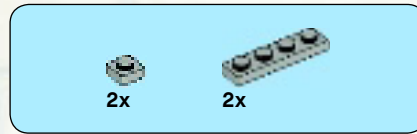
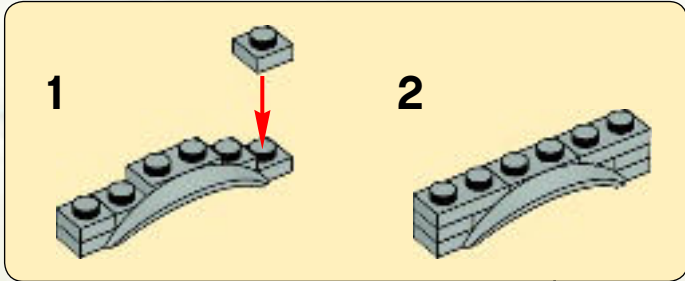

16

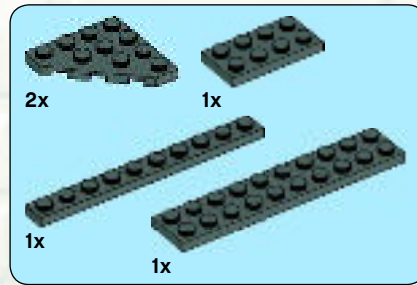
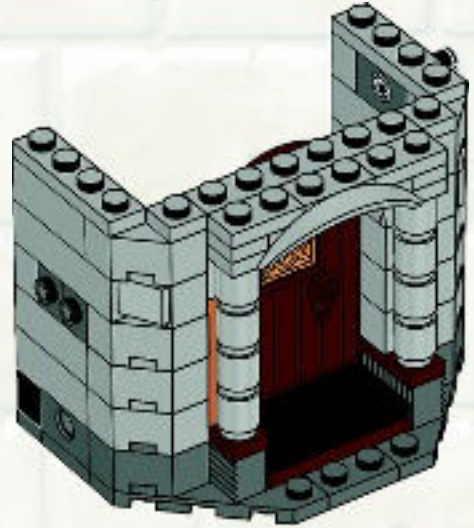

17

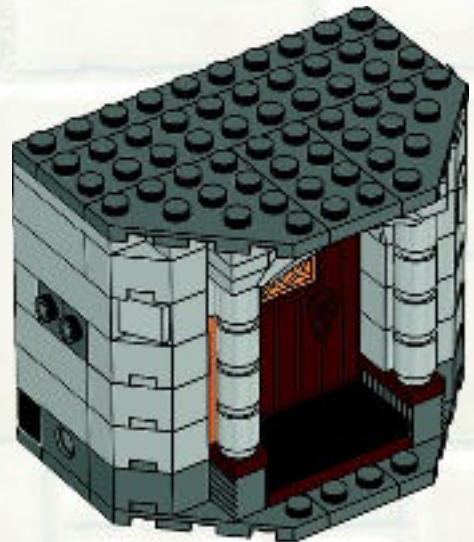



18

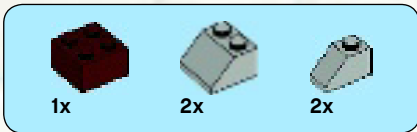
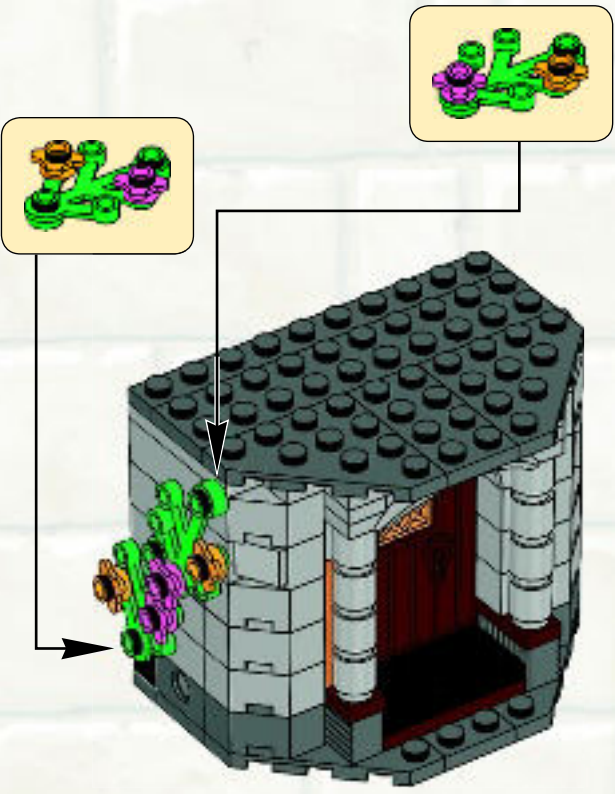

19

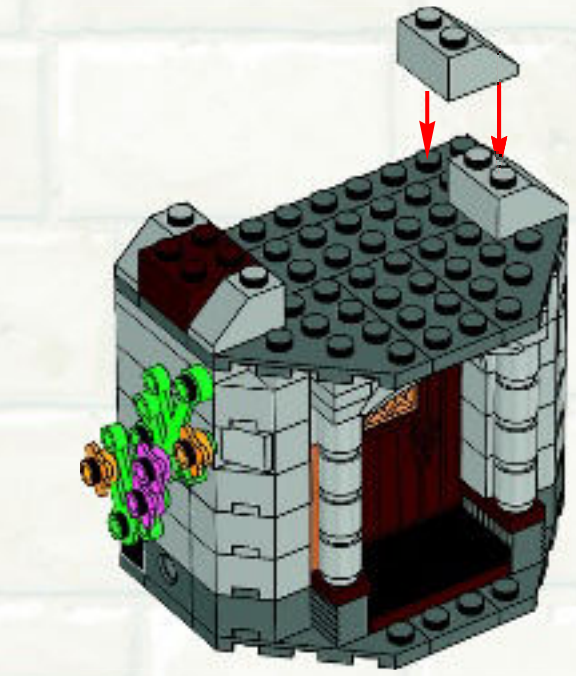

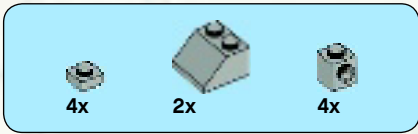

20

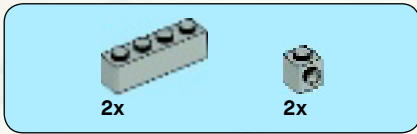
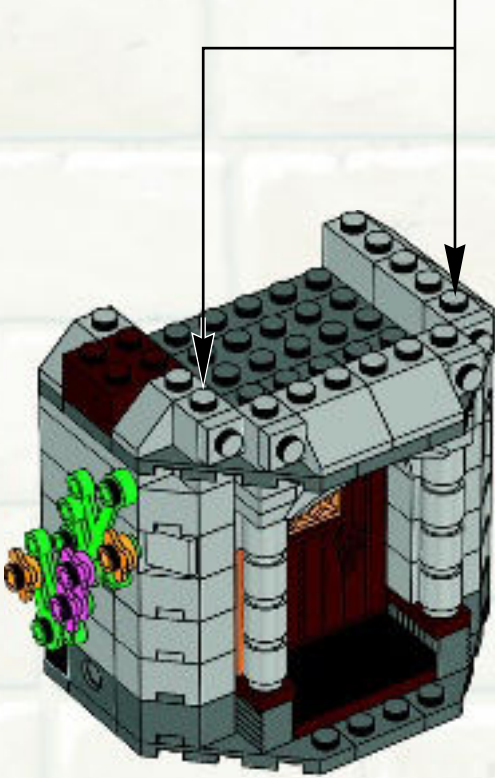
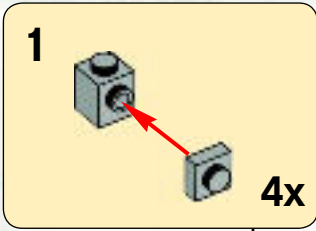

21

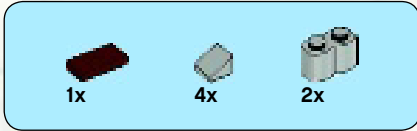
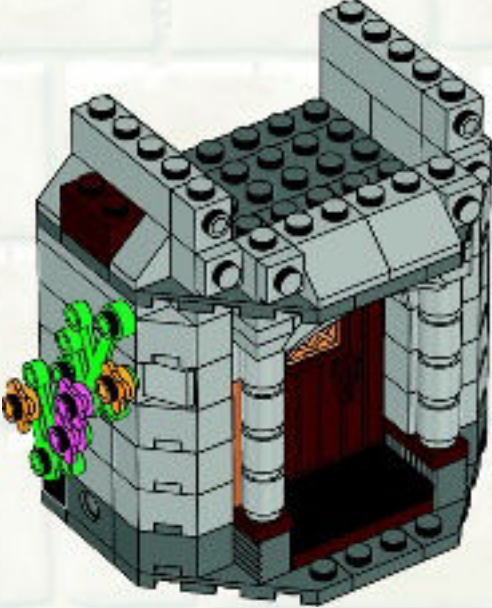

22

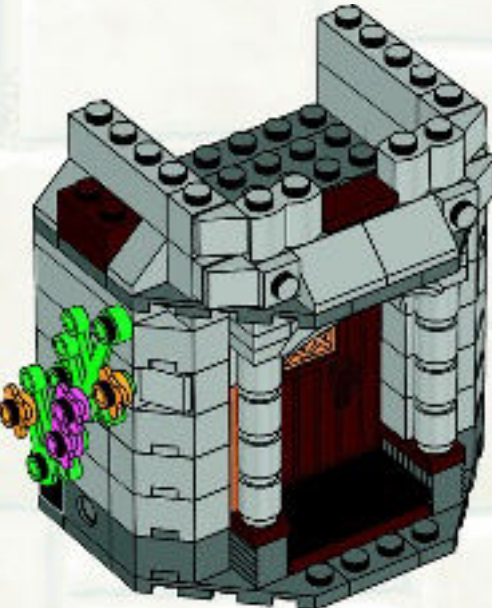

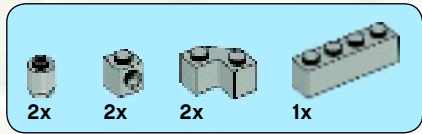

23

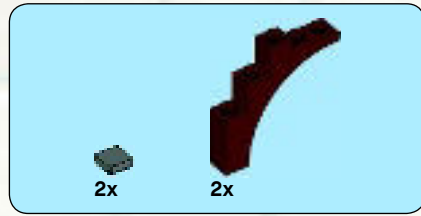
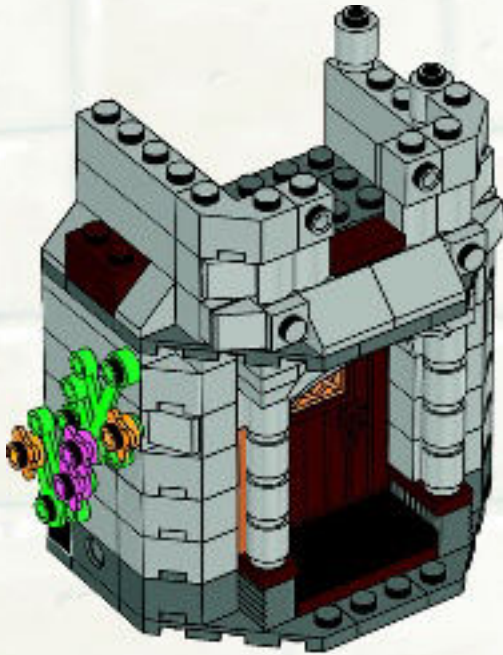

24

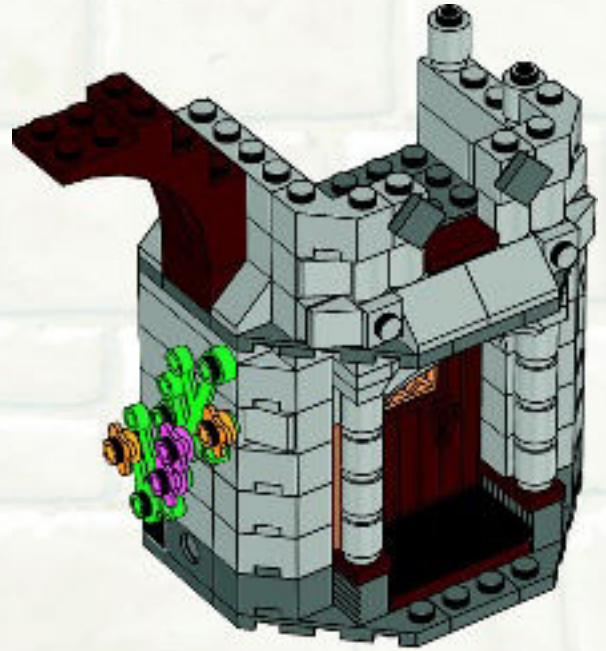



25

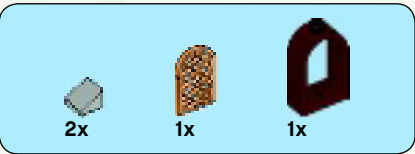

26



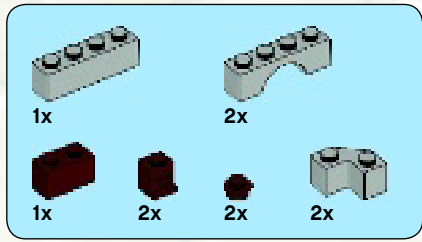

27

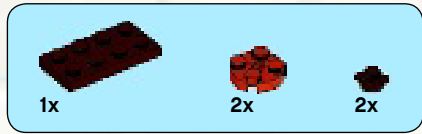
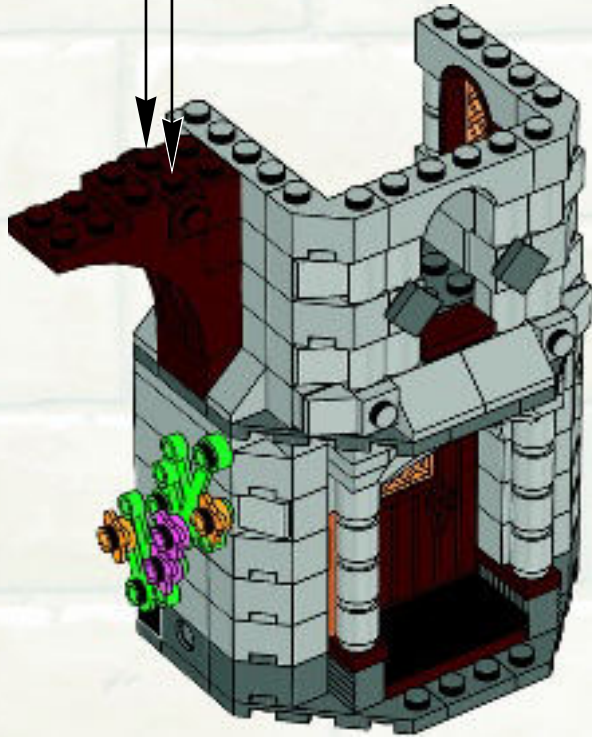
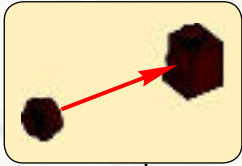

28

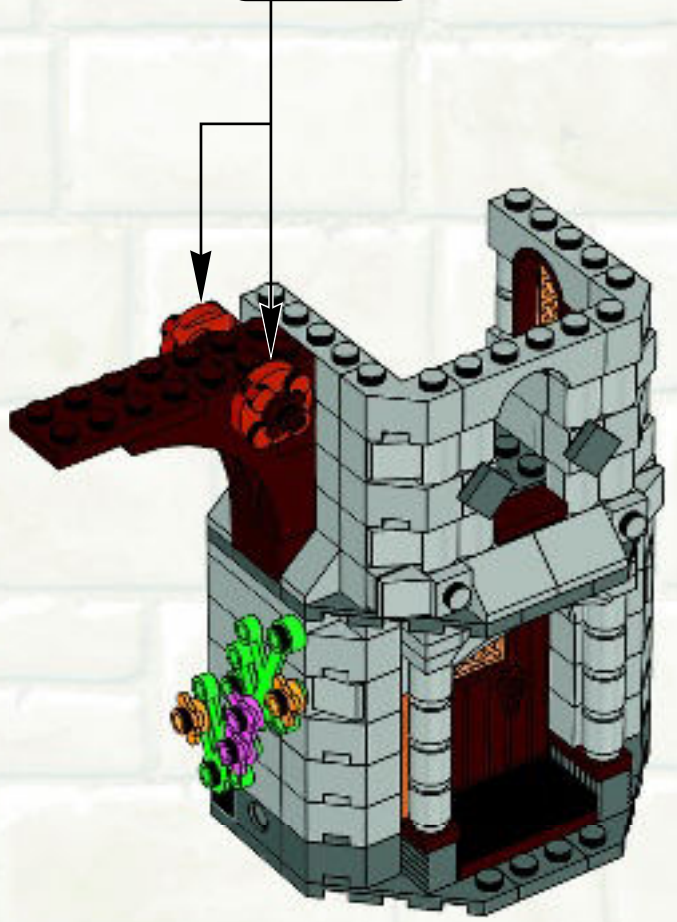
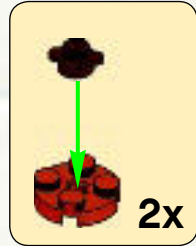

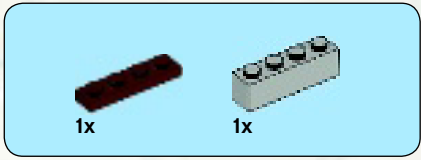

1

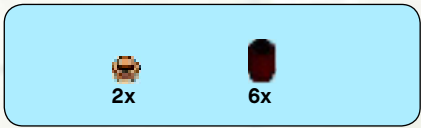
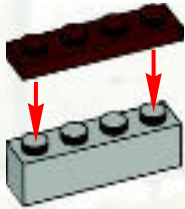

2

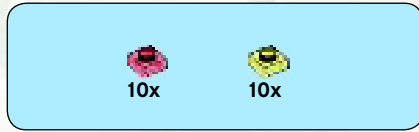
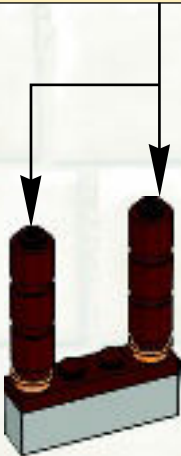
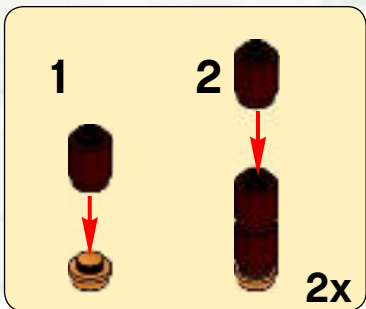

3

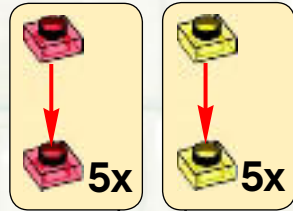



4

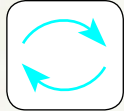

29



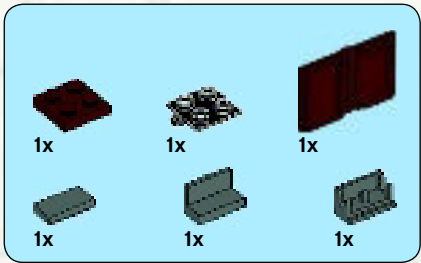

30

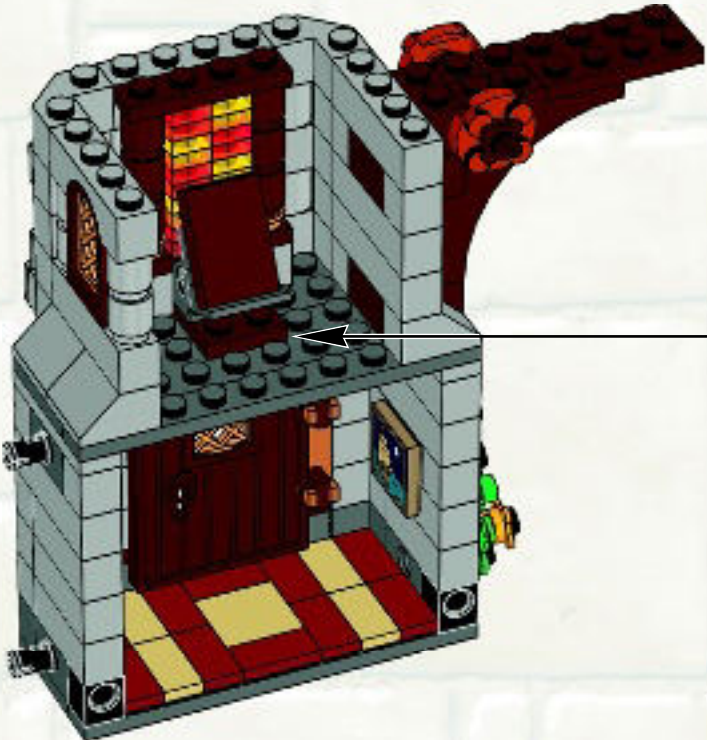
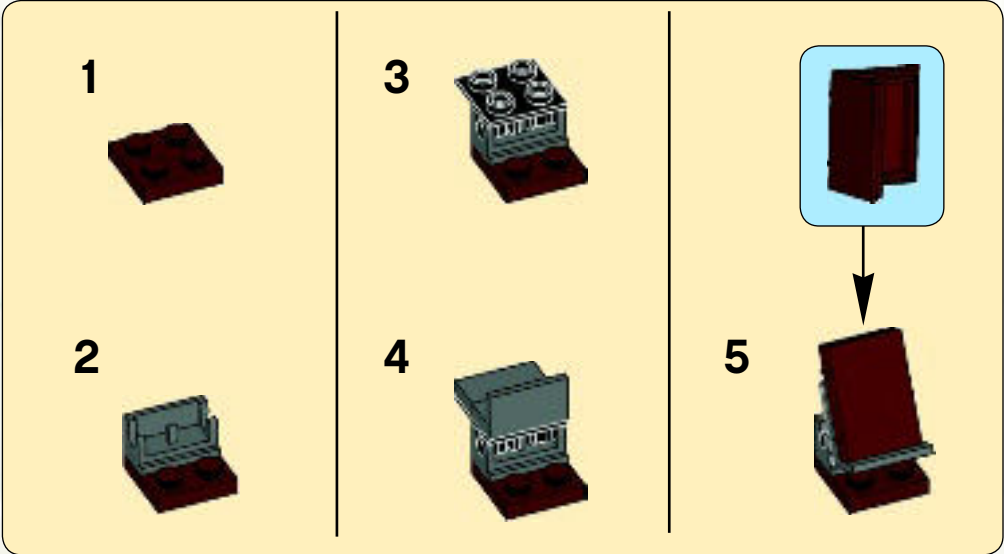

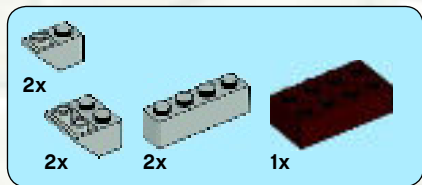

31

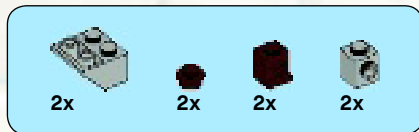
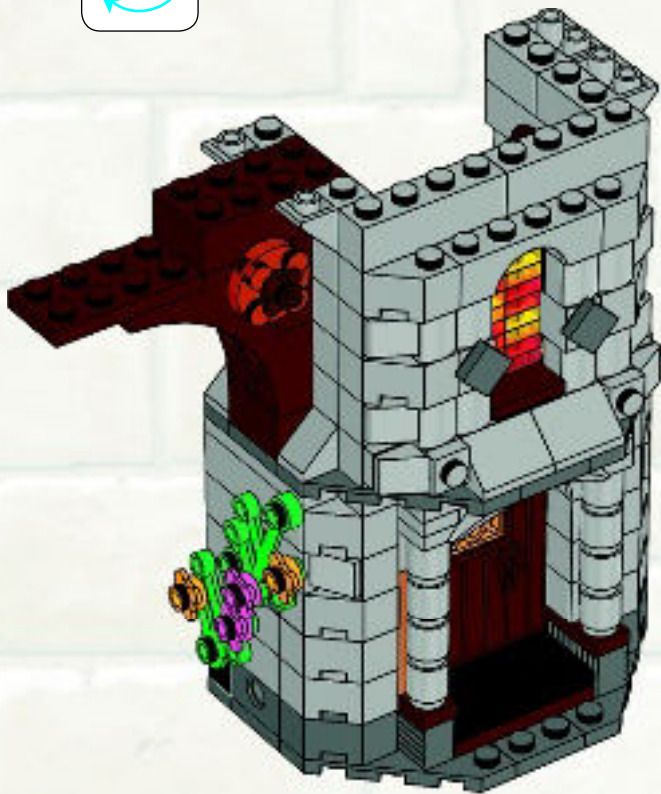
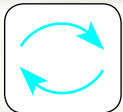

32

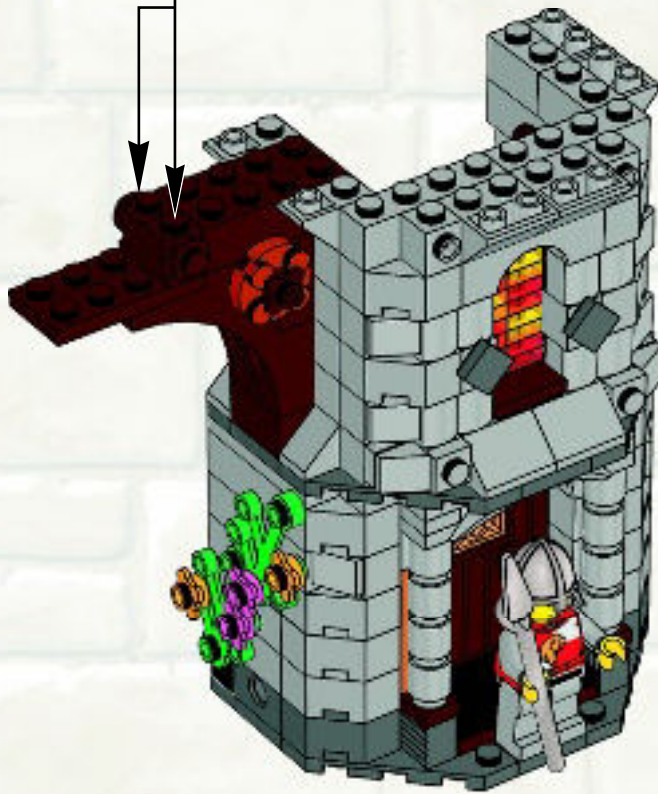
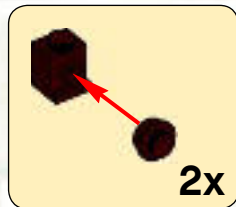

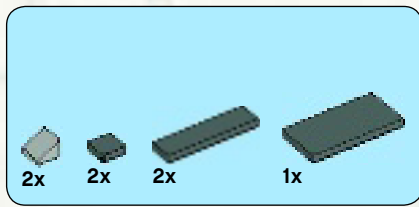

33

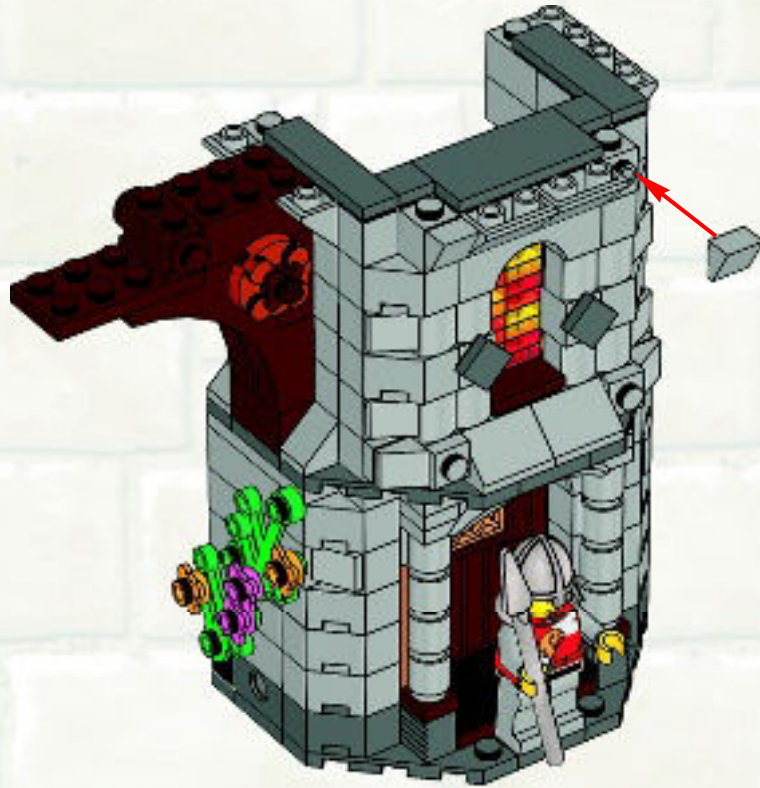

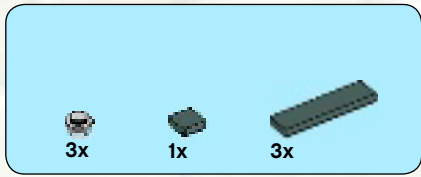

34

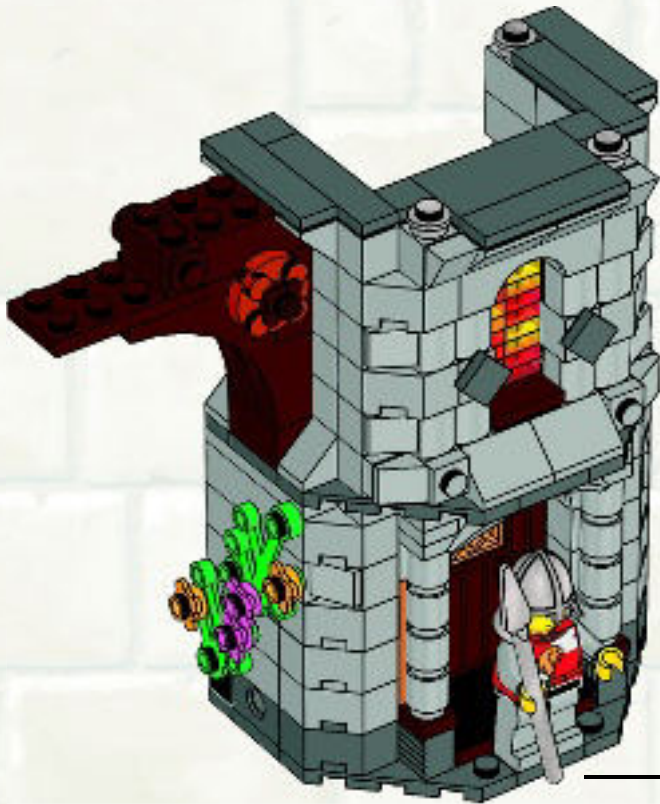

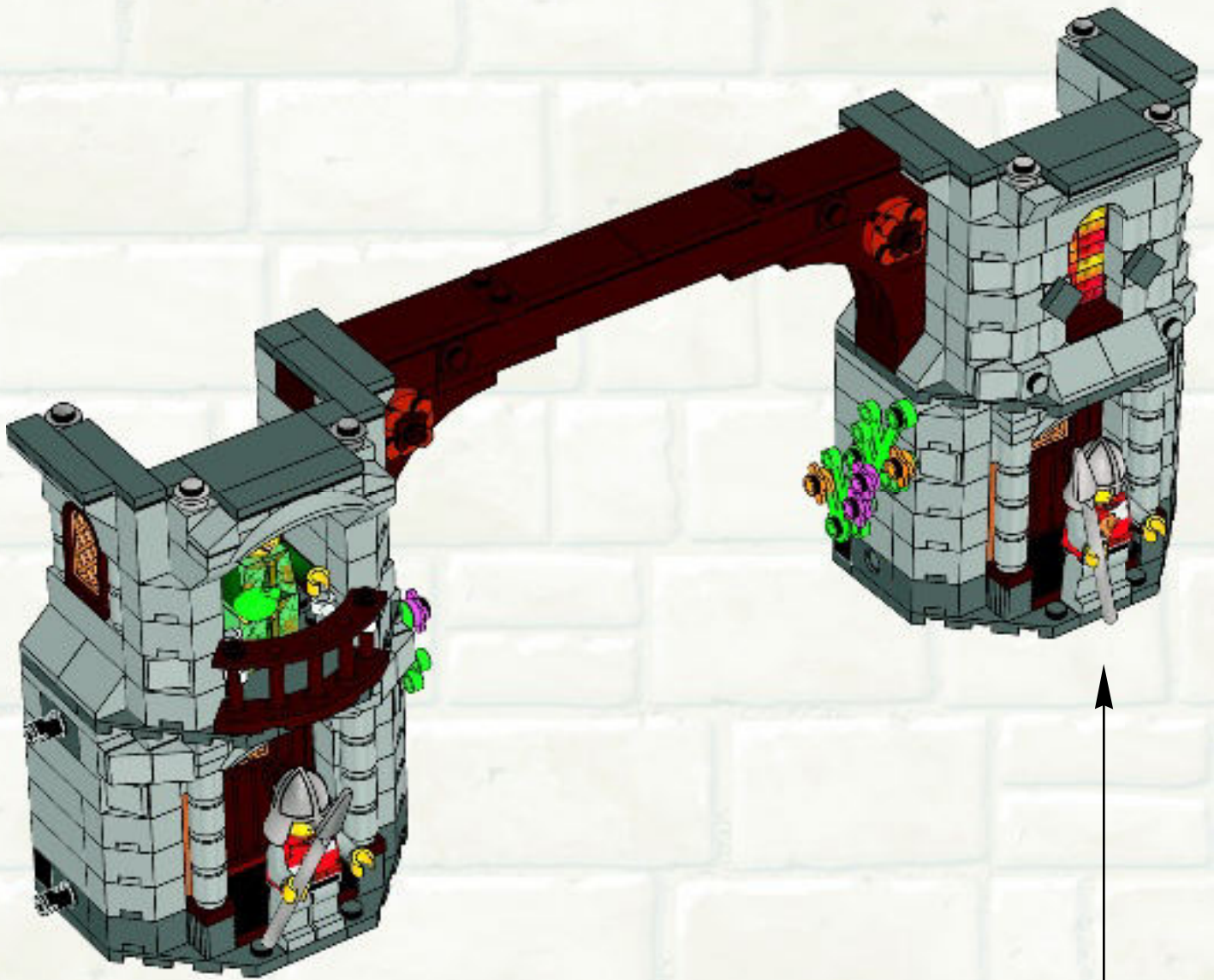

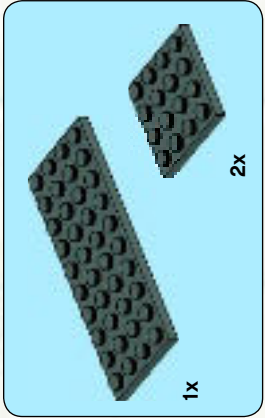
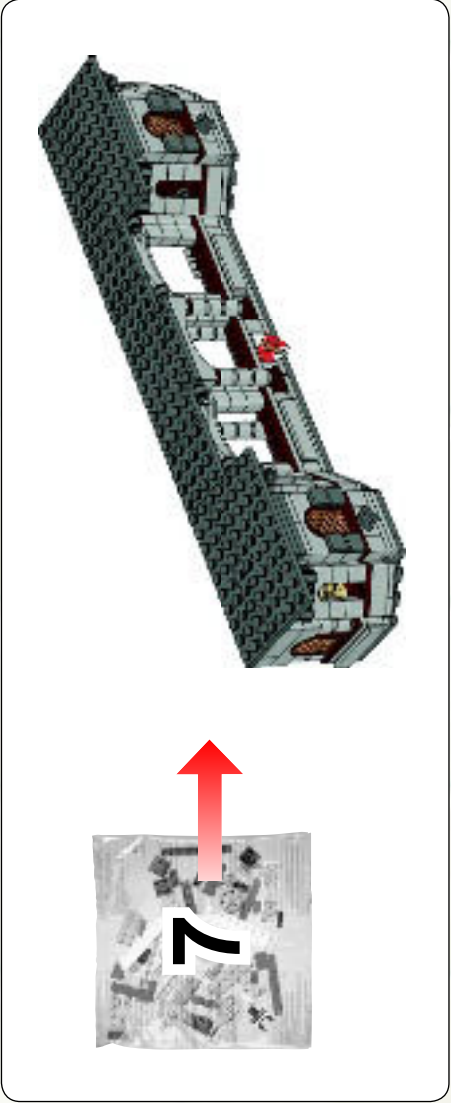

1

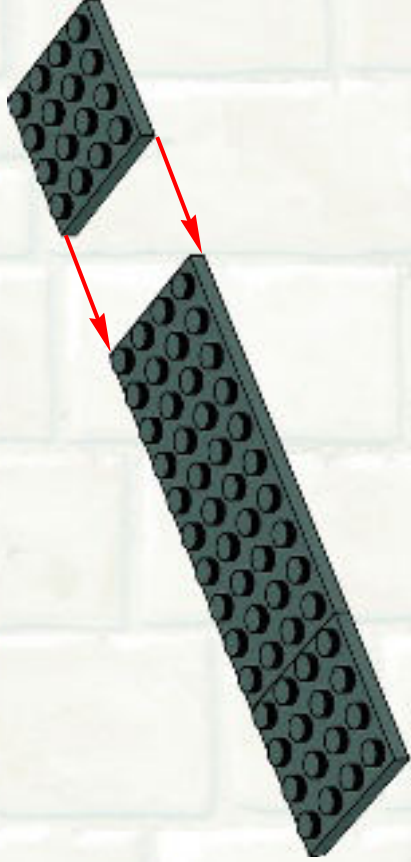

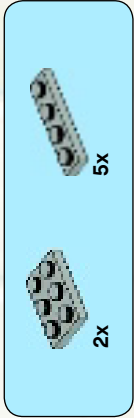

2



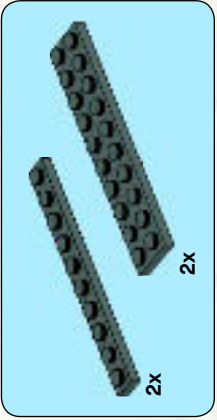



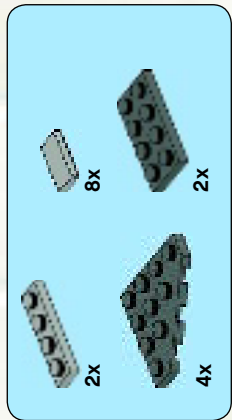
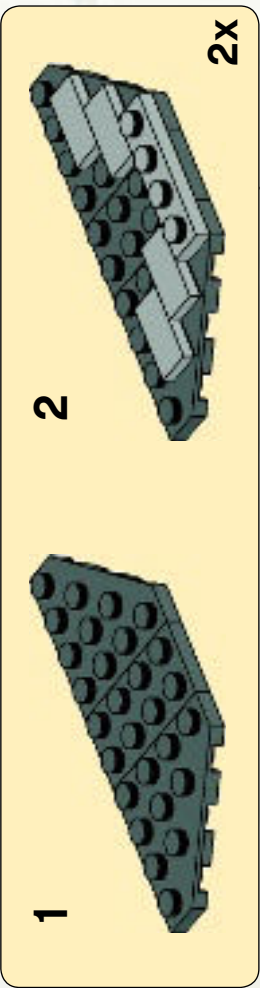

3

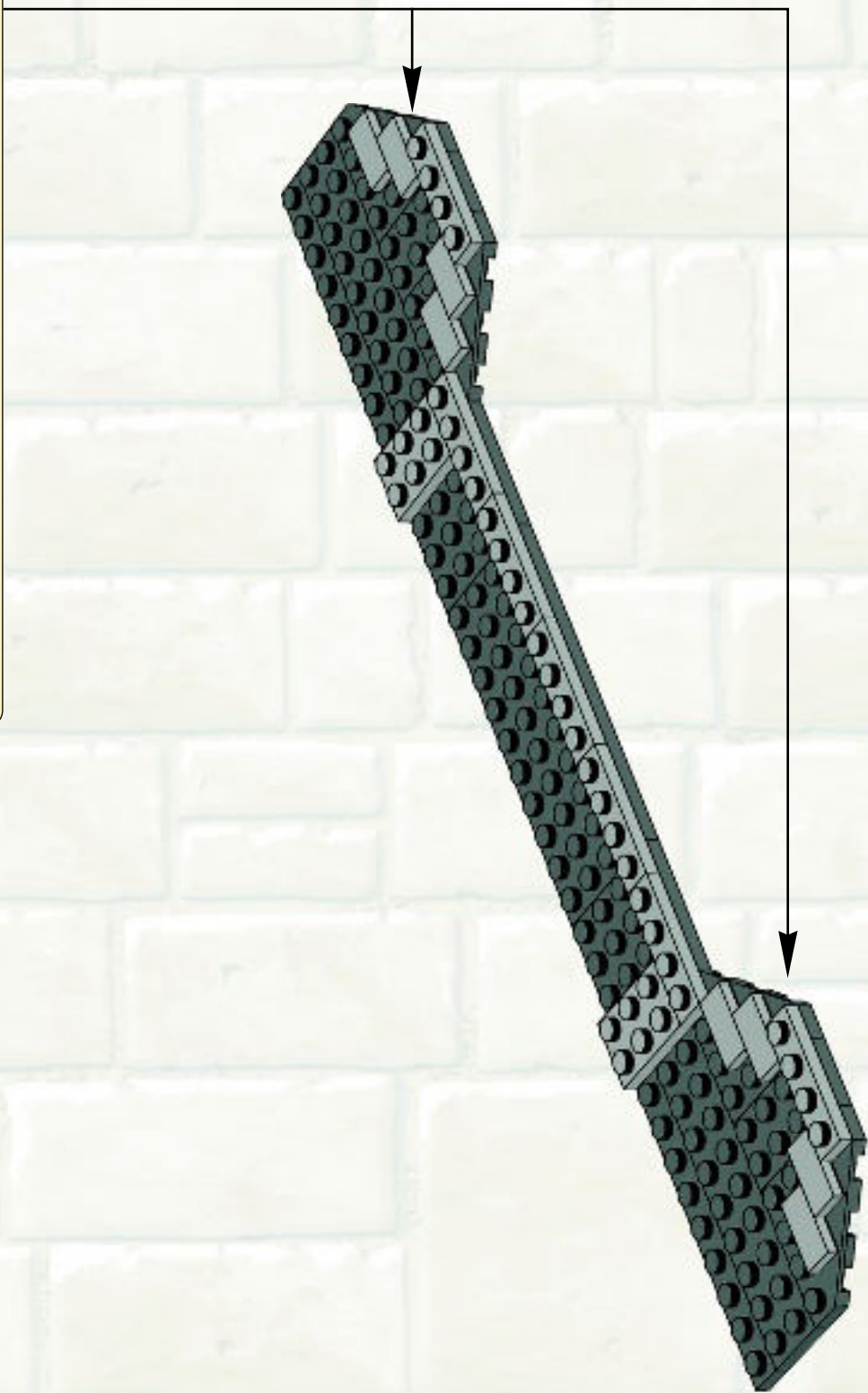

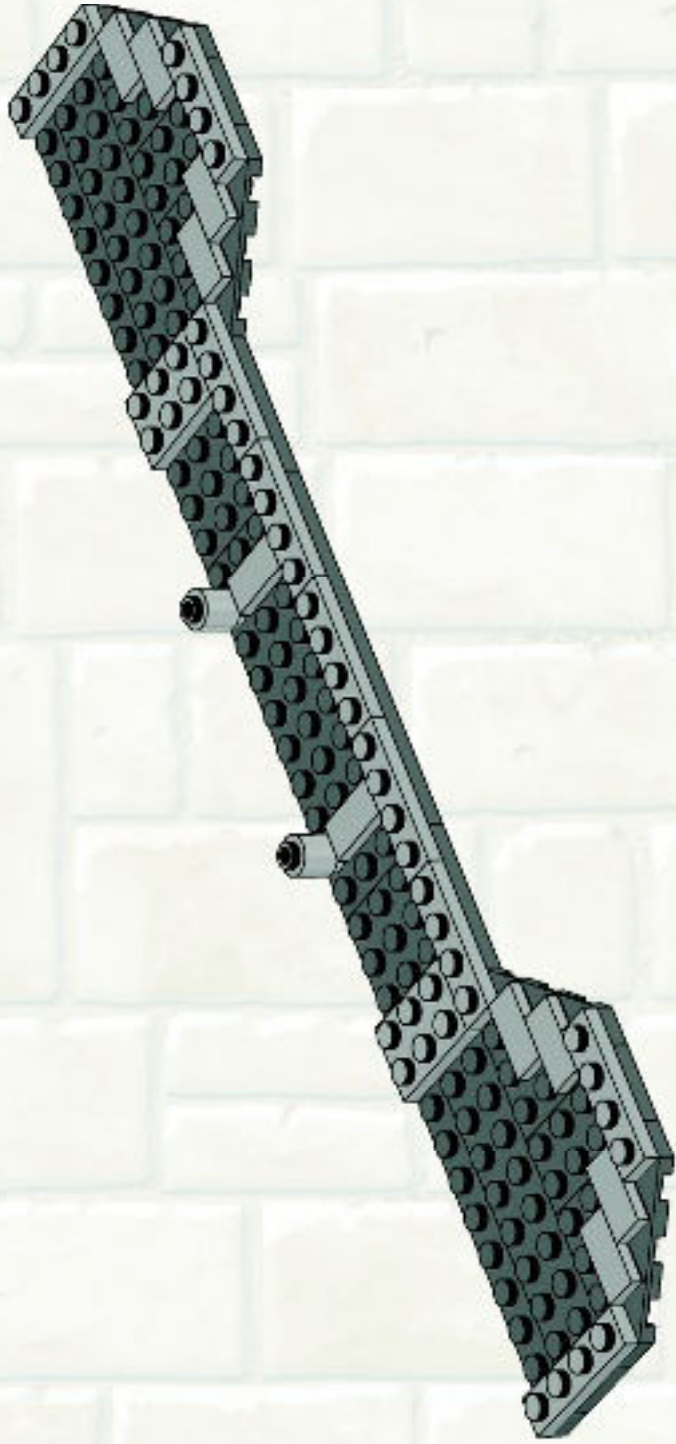
4





2x  2x  2x 

5

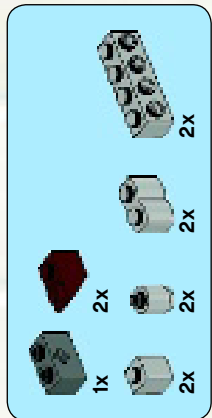



6

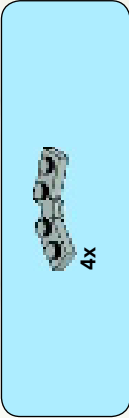
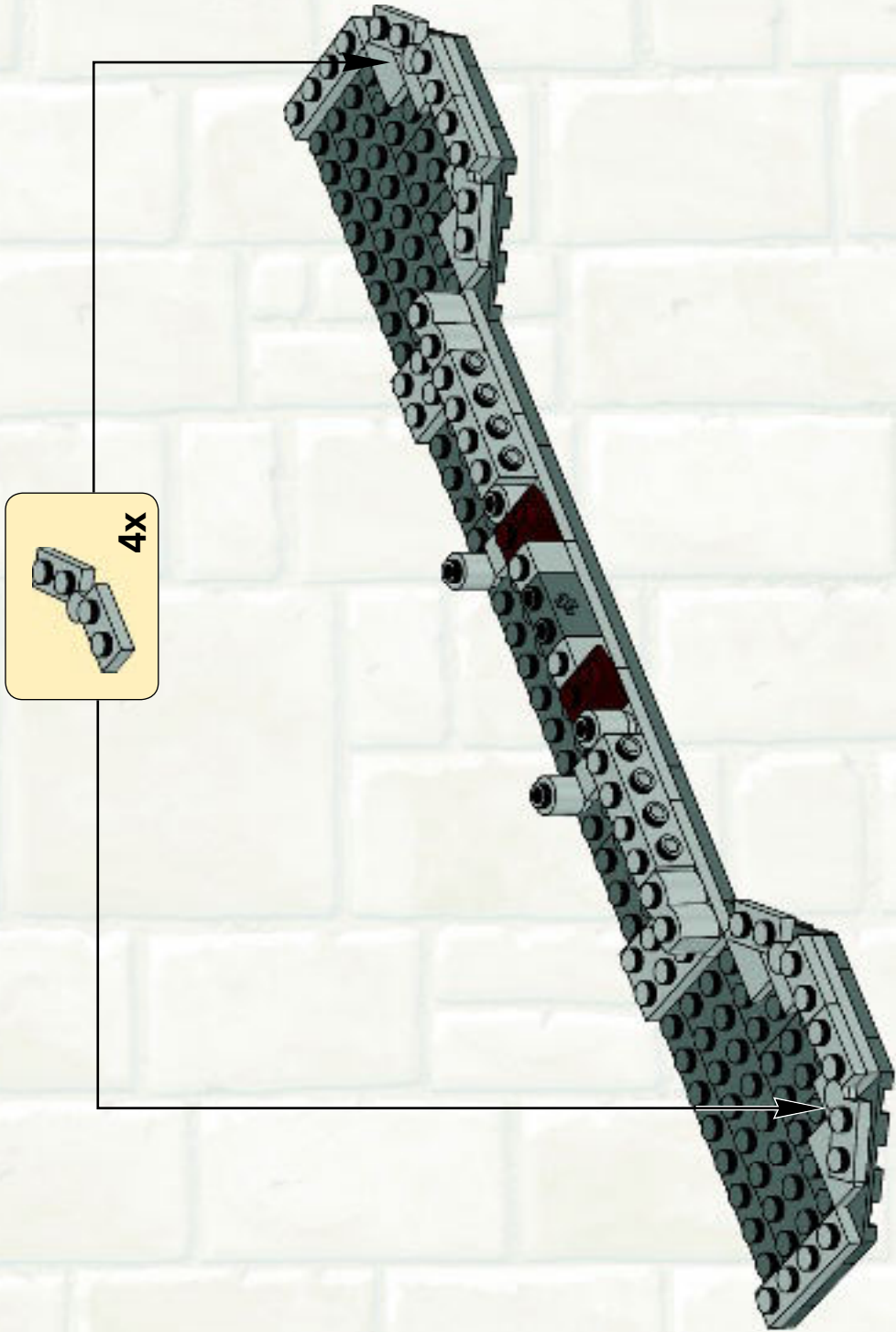



7



-  2x
-  2x
-  4x

8

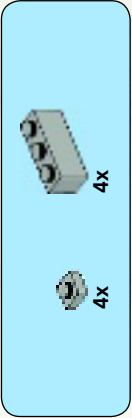
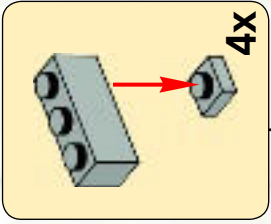

9

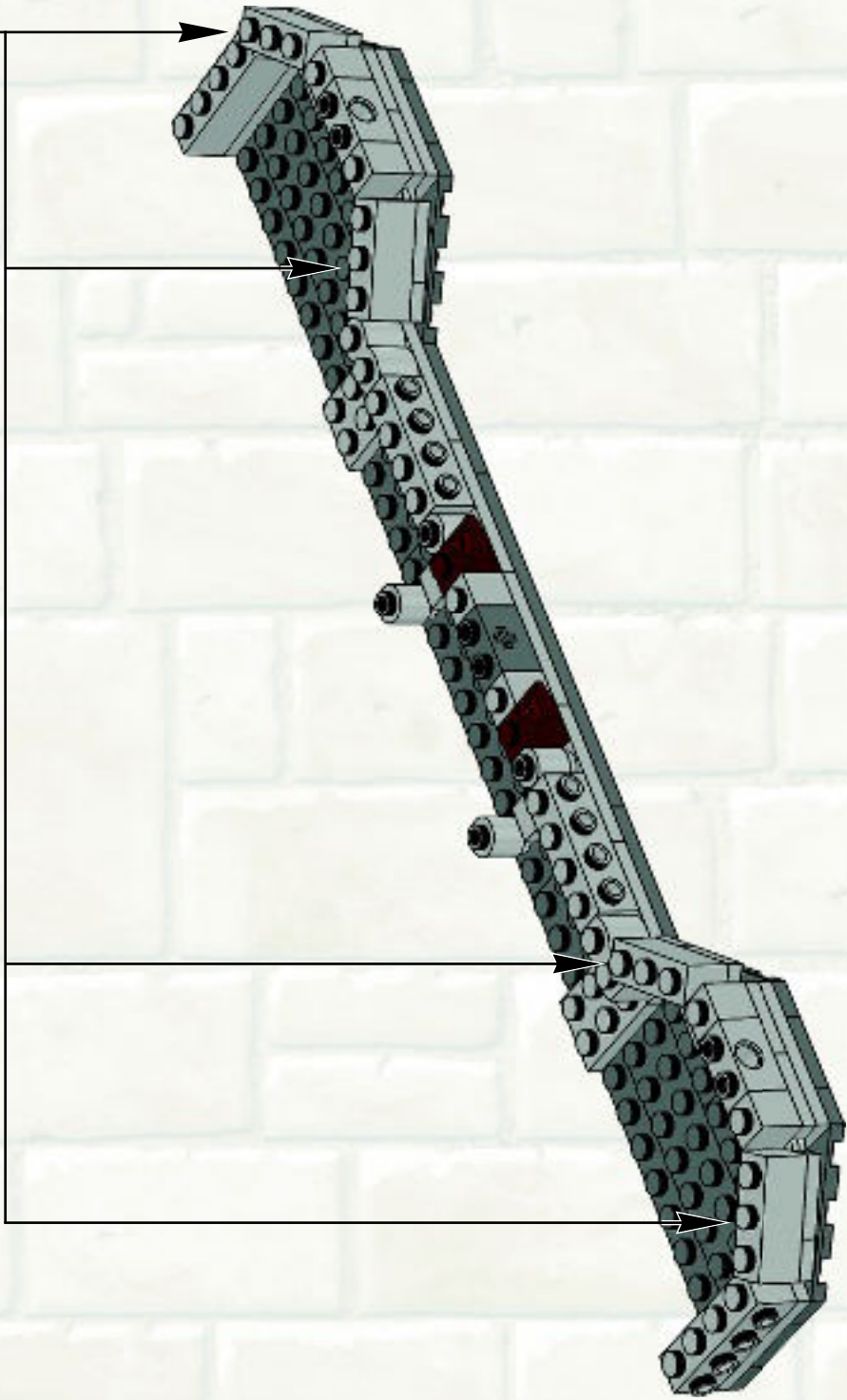

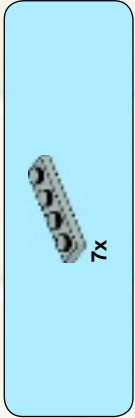

10

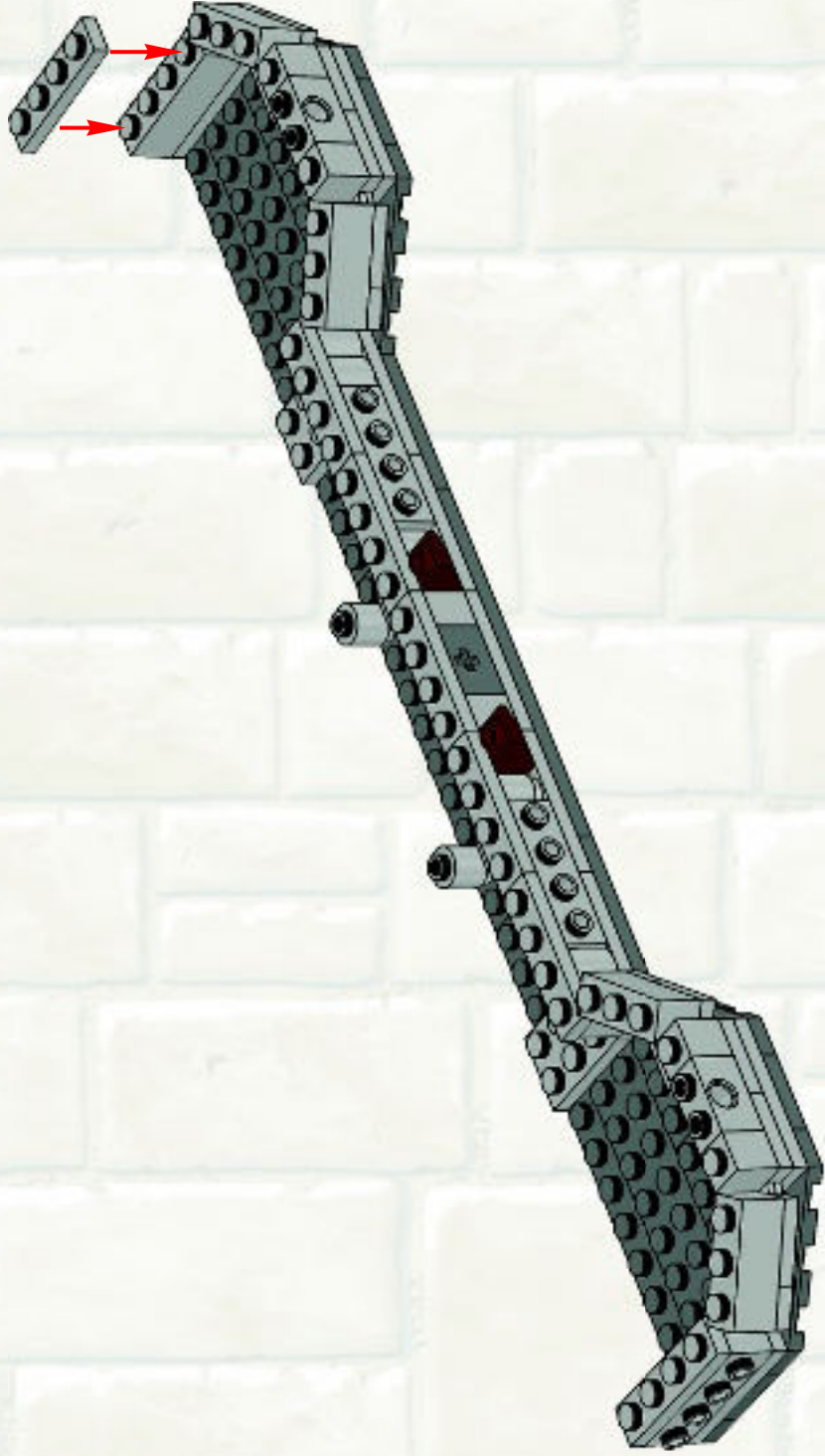



6x
8x
4x

A light blue rounded rectangular box containing a parts list. On the left side, there are three dark red LEGO parts: a 1x3 brick, a 1x6 brick, and a 1x2 brick with a hole. To the right of each part is its quantity: '6x' for the 1x3 brick, '8x' for the 1x6 brick, and '4x' for the 1x2 brick with a hole.

11

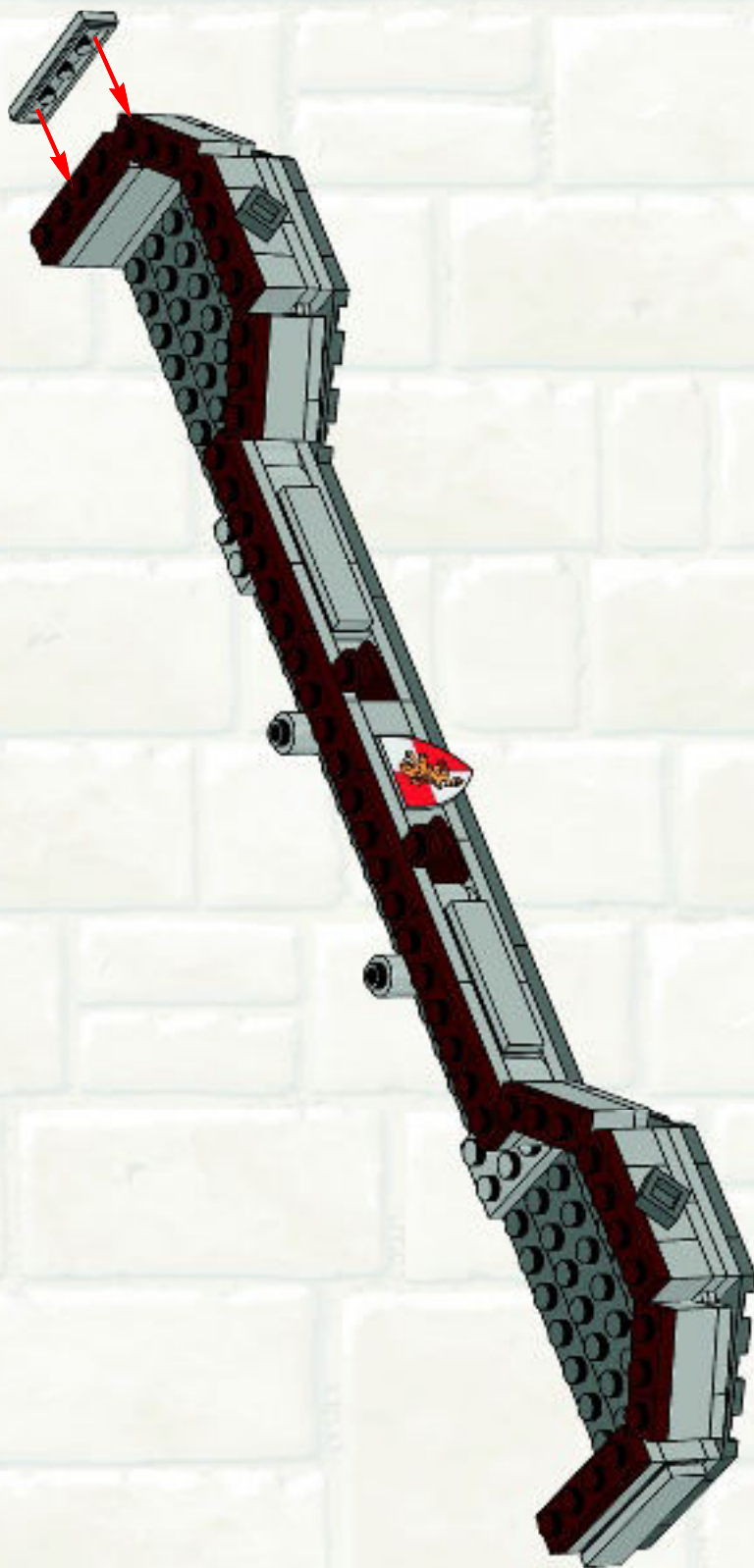

2x 2x 4x 1x

12

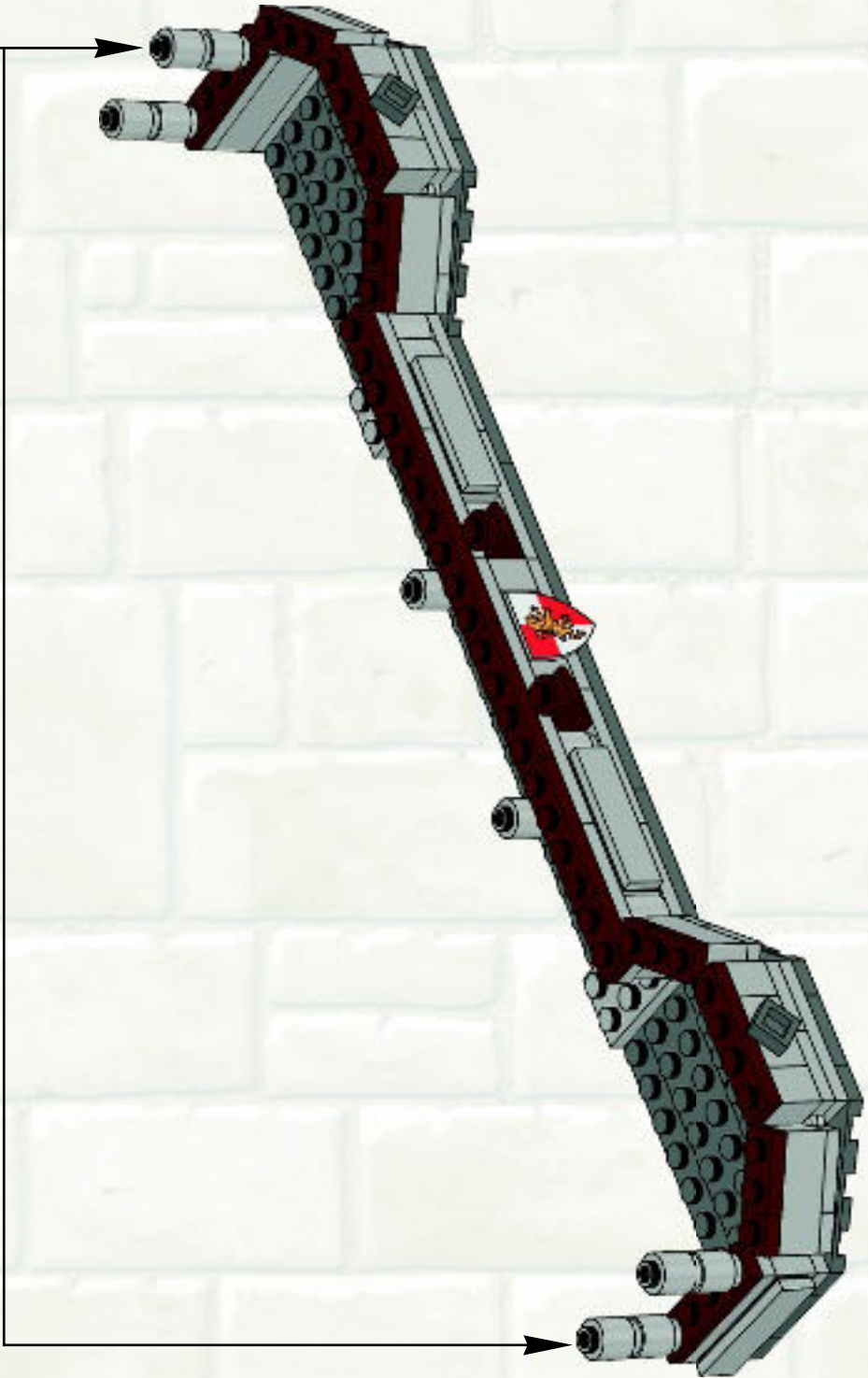
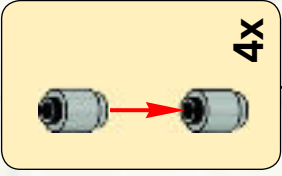

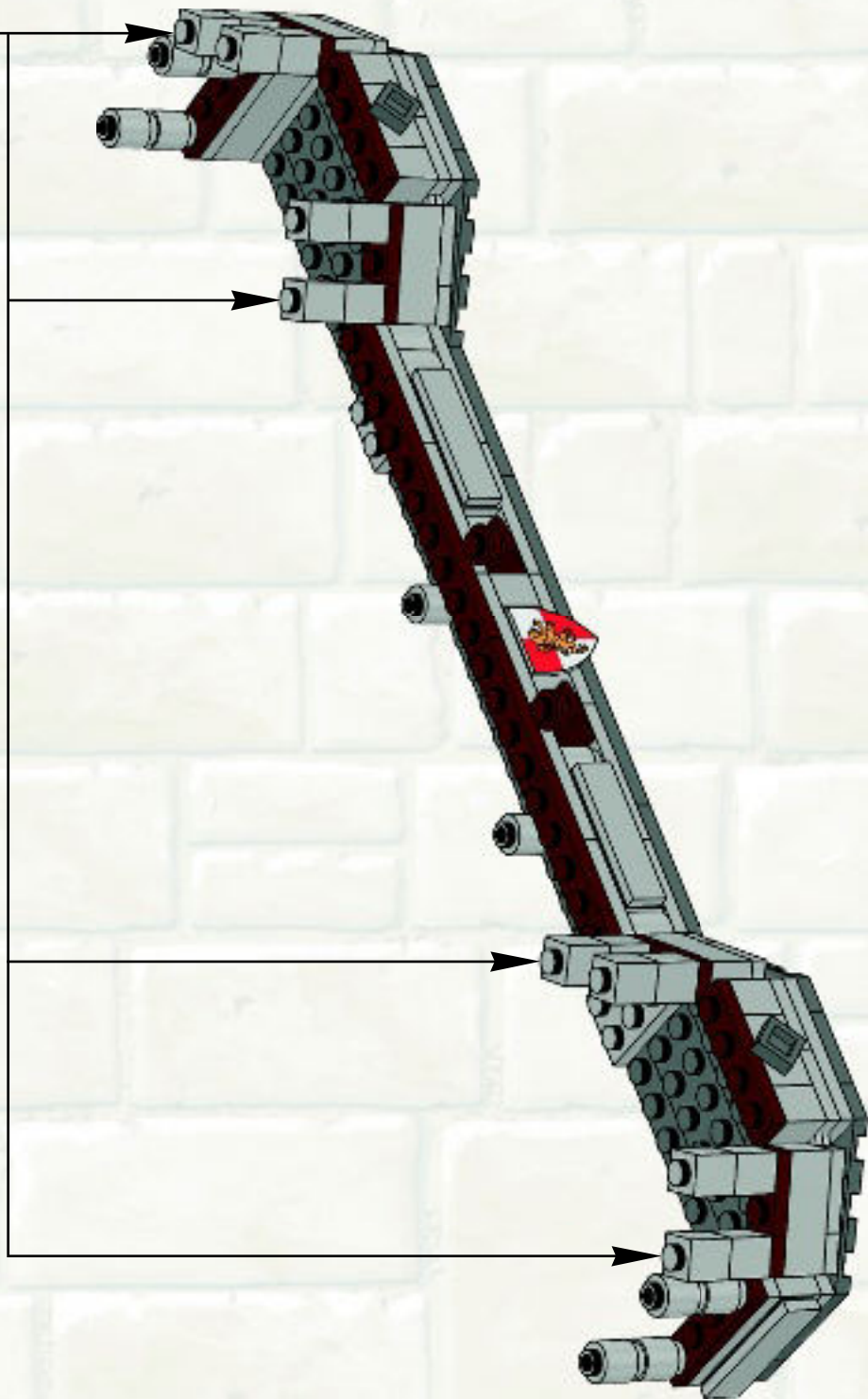
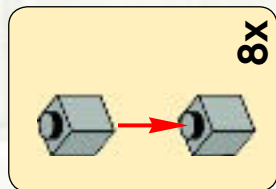

13



16x

14

8x  8x 

15

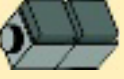
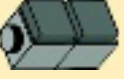
1  2  4x 

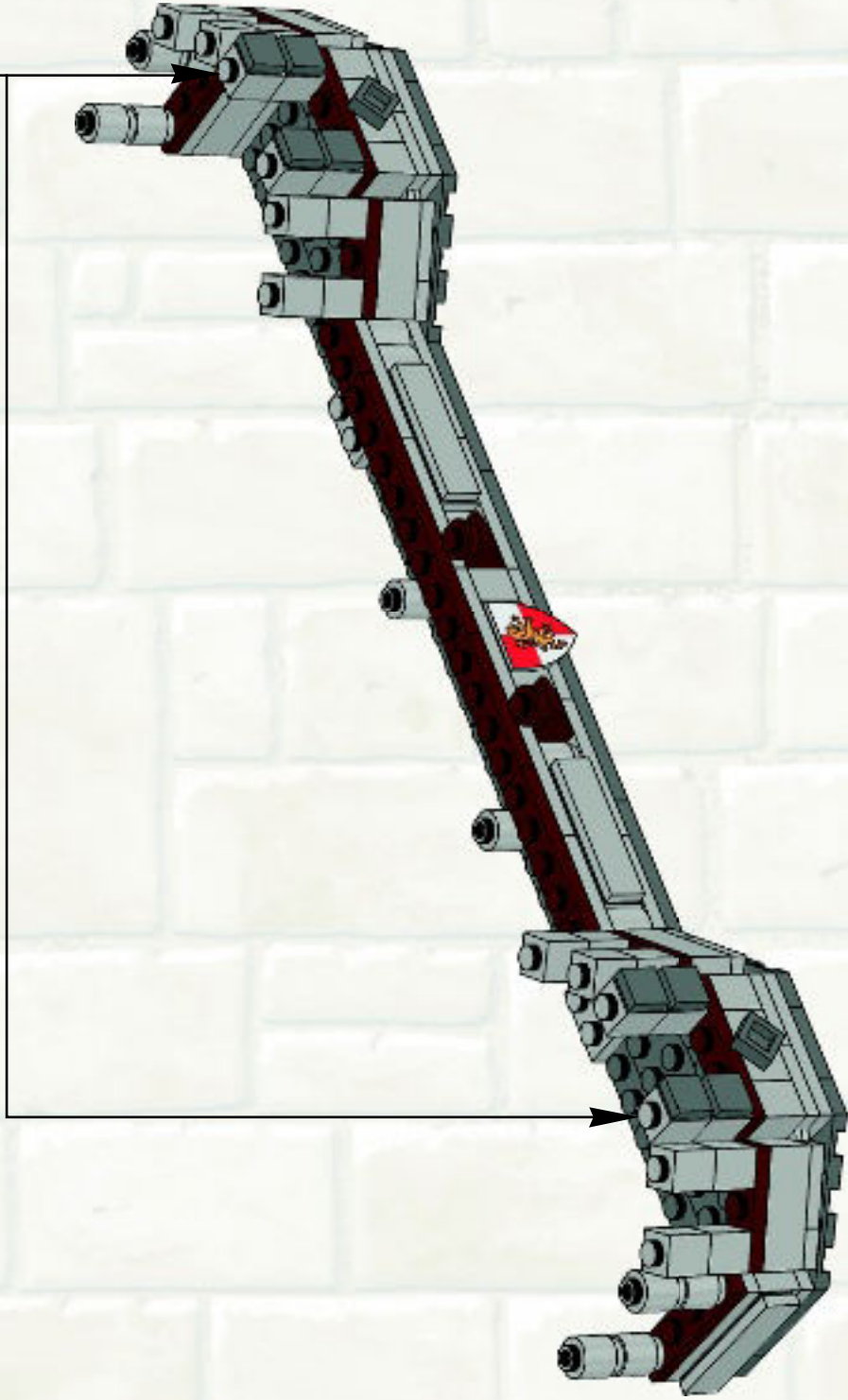

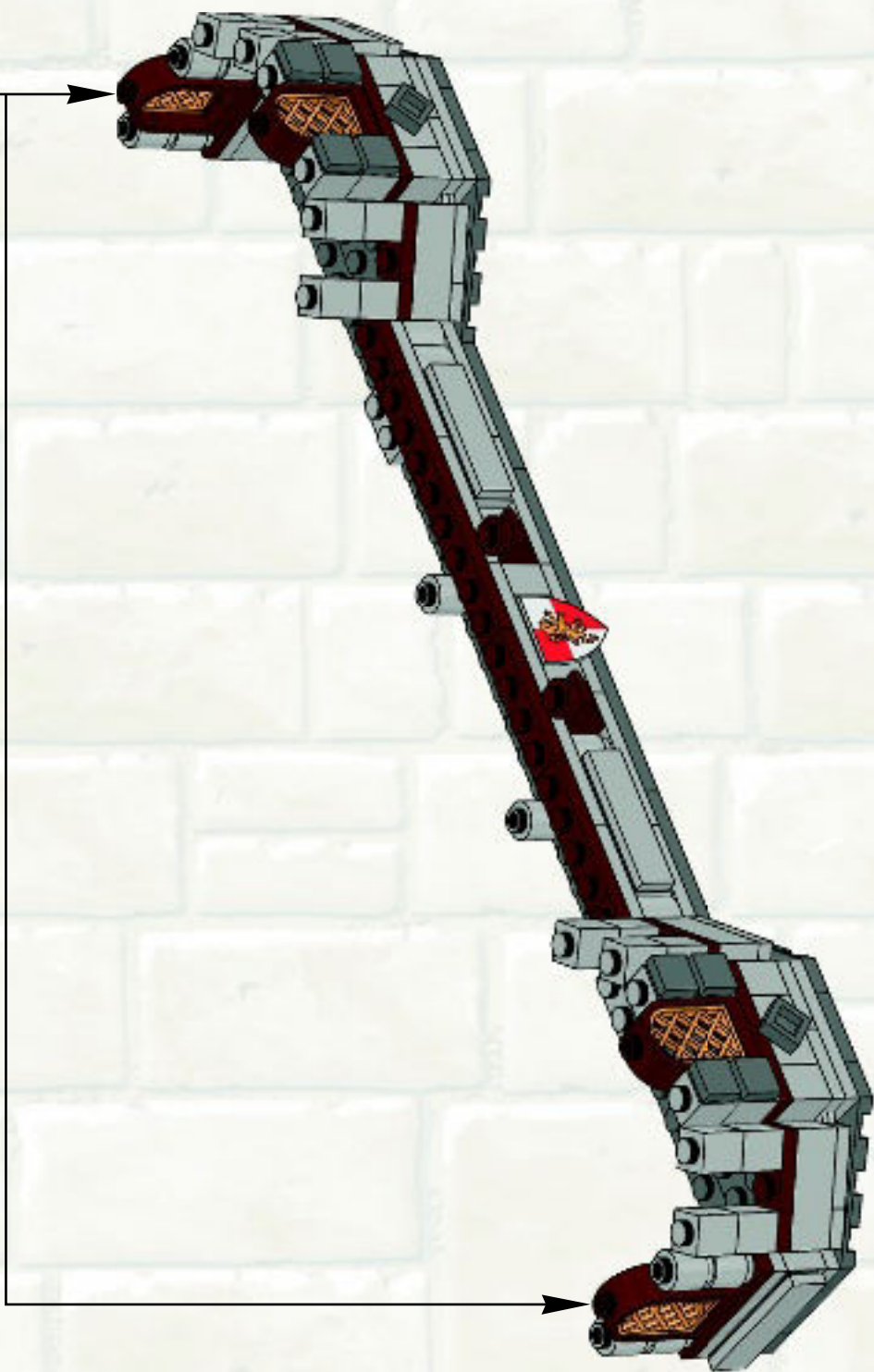

16

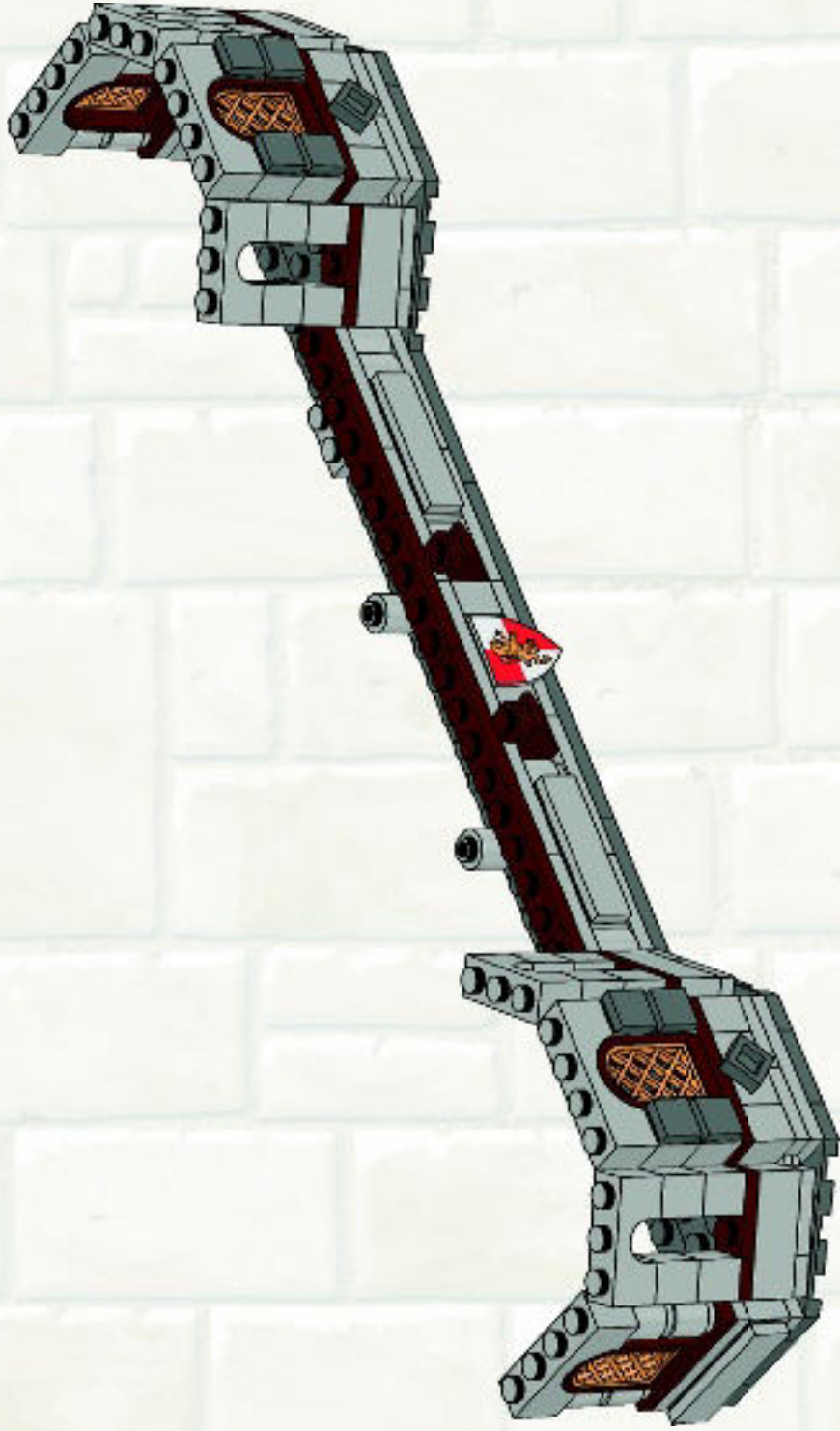

4x 

4x 

17

12x



18

4x

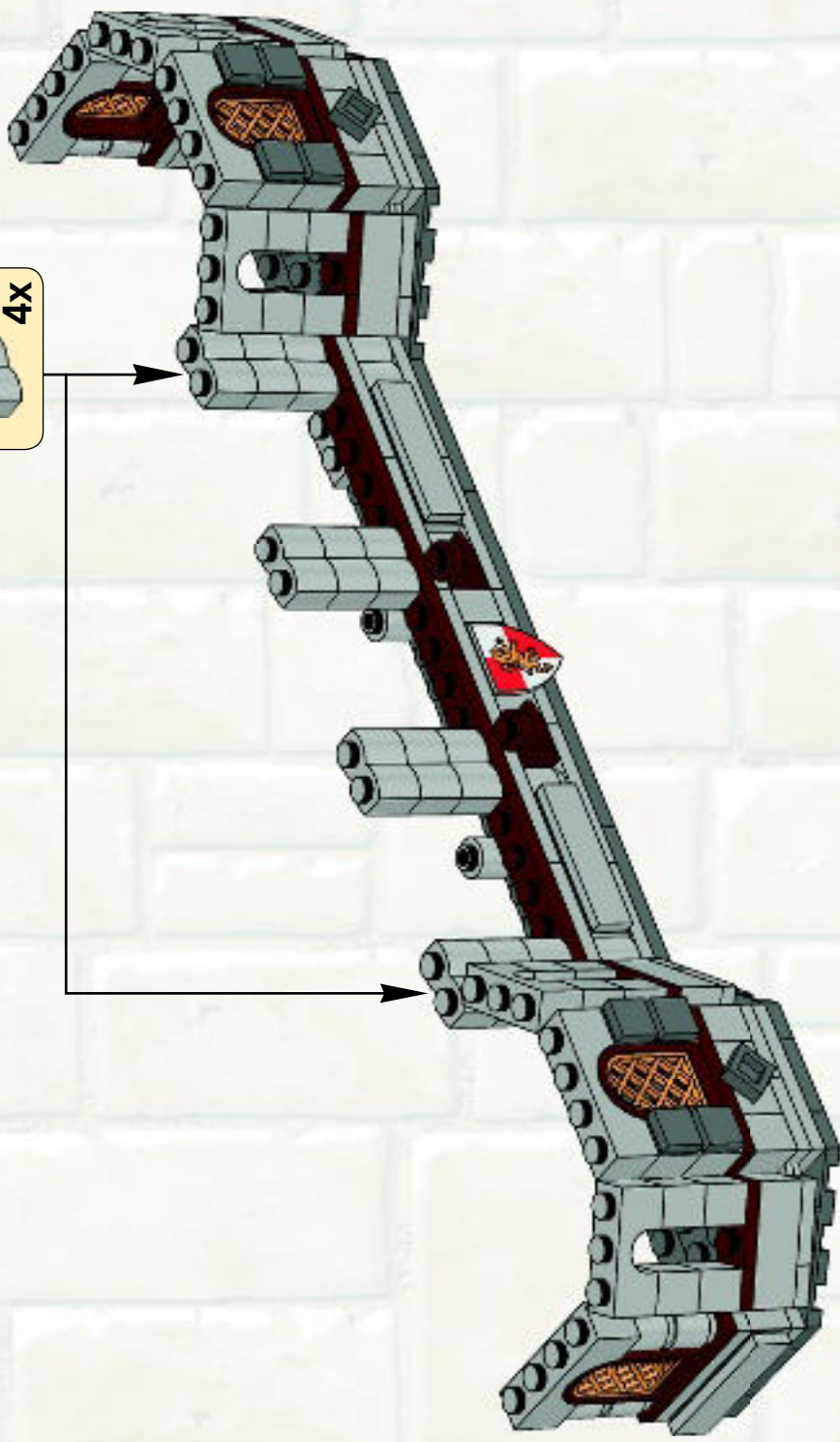
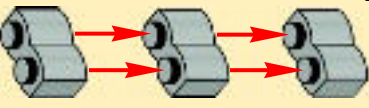

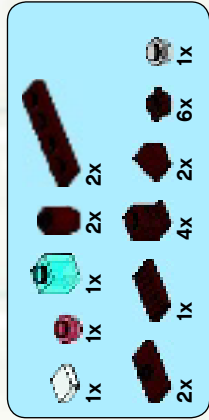



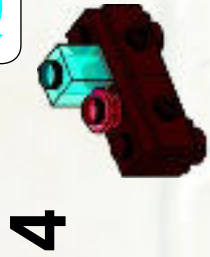
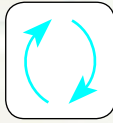
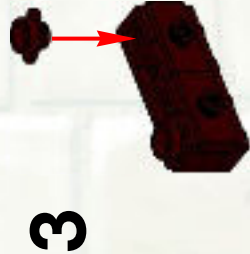
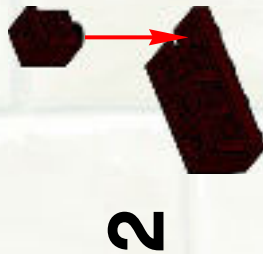

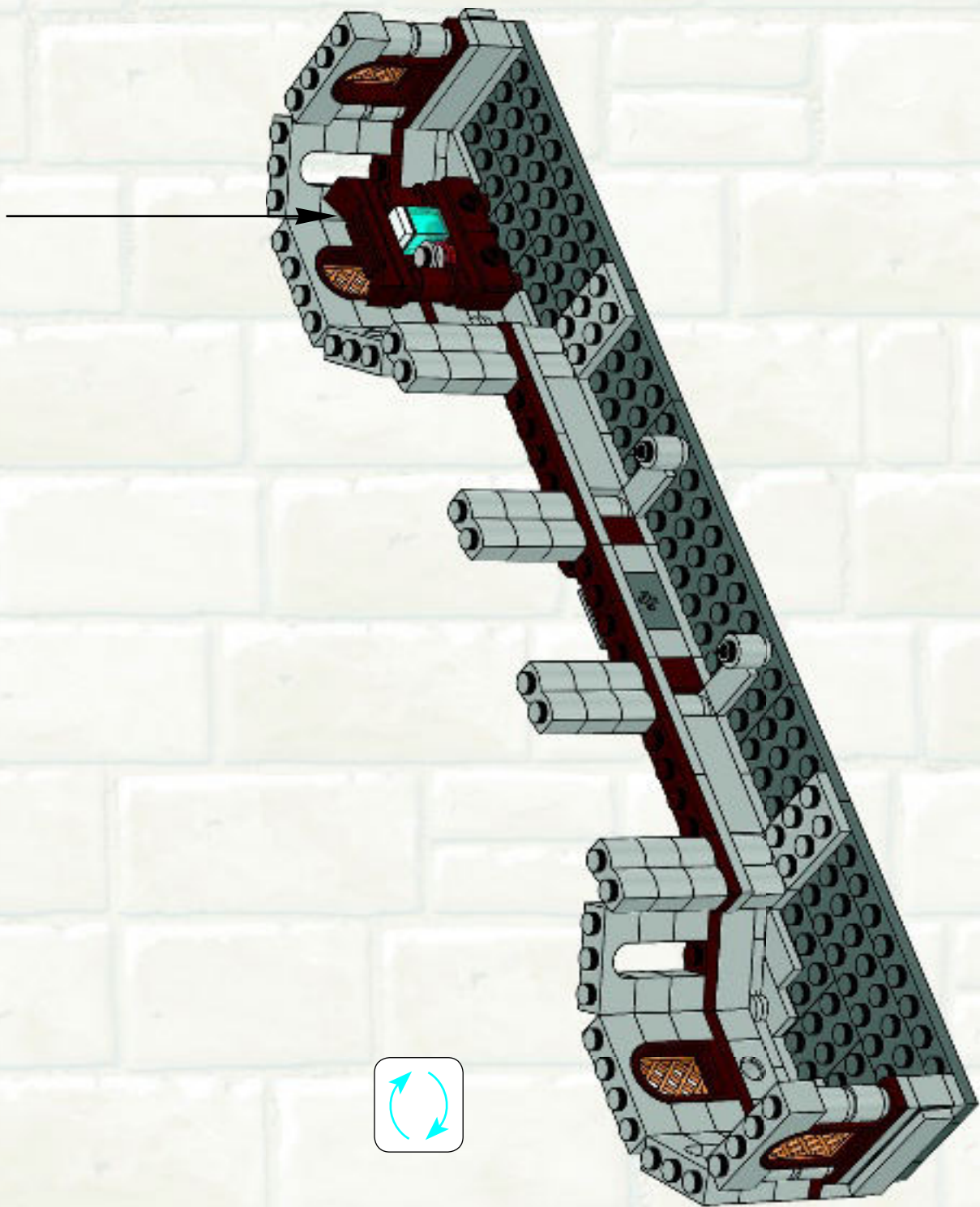
19





1x  4x 

20

1  2  3  

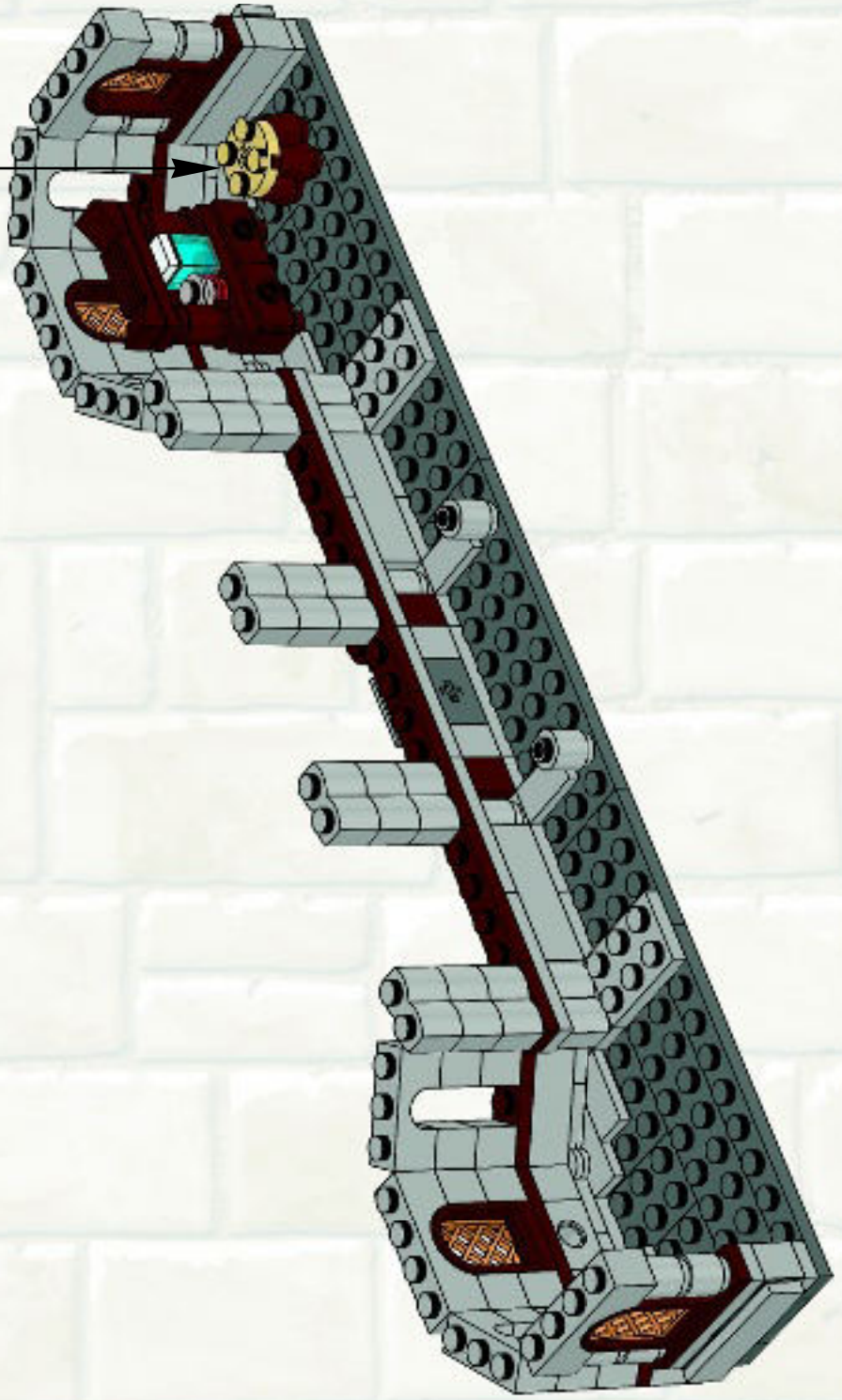

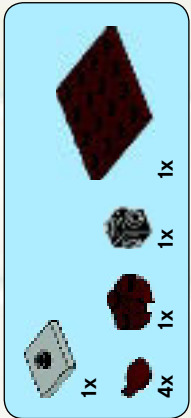

21

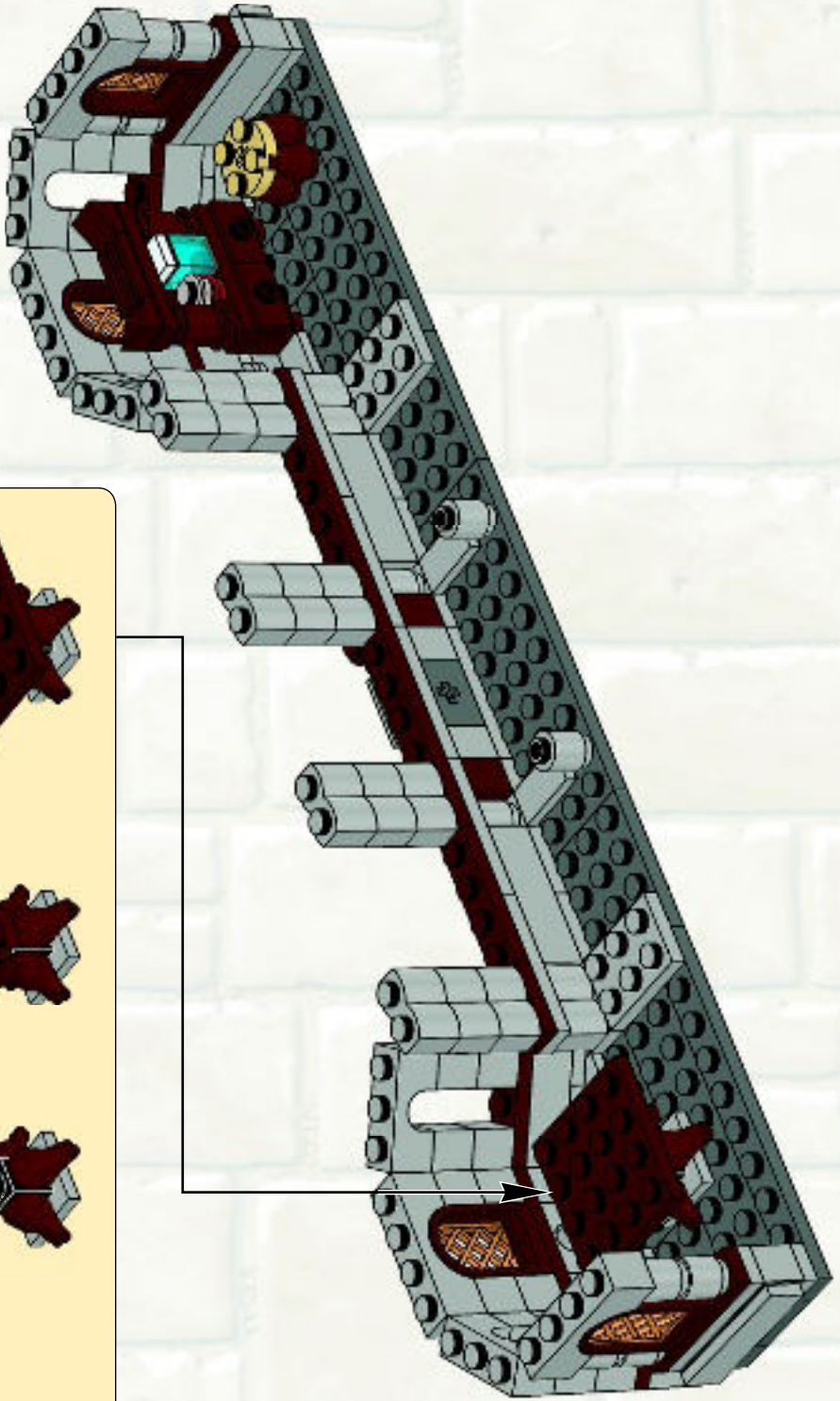

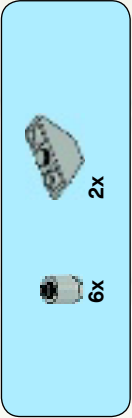
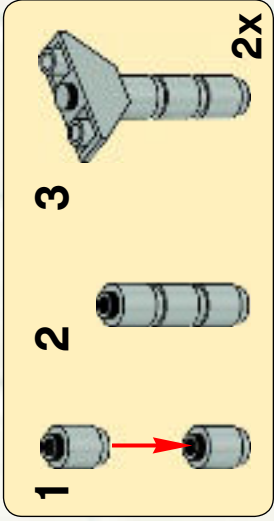
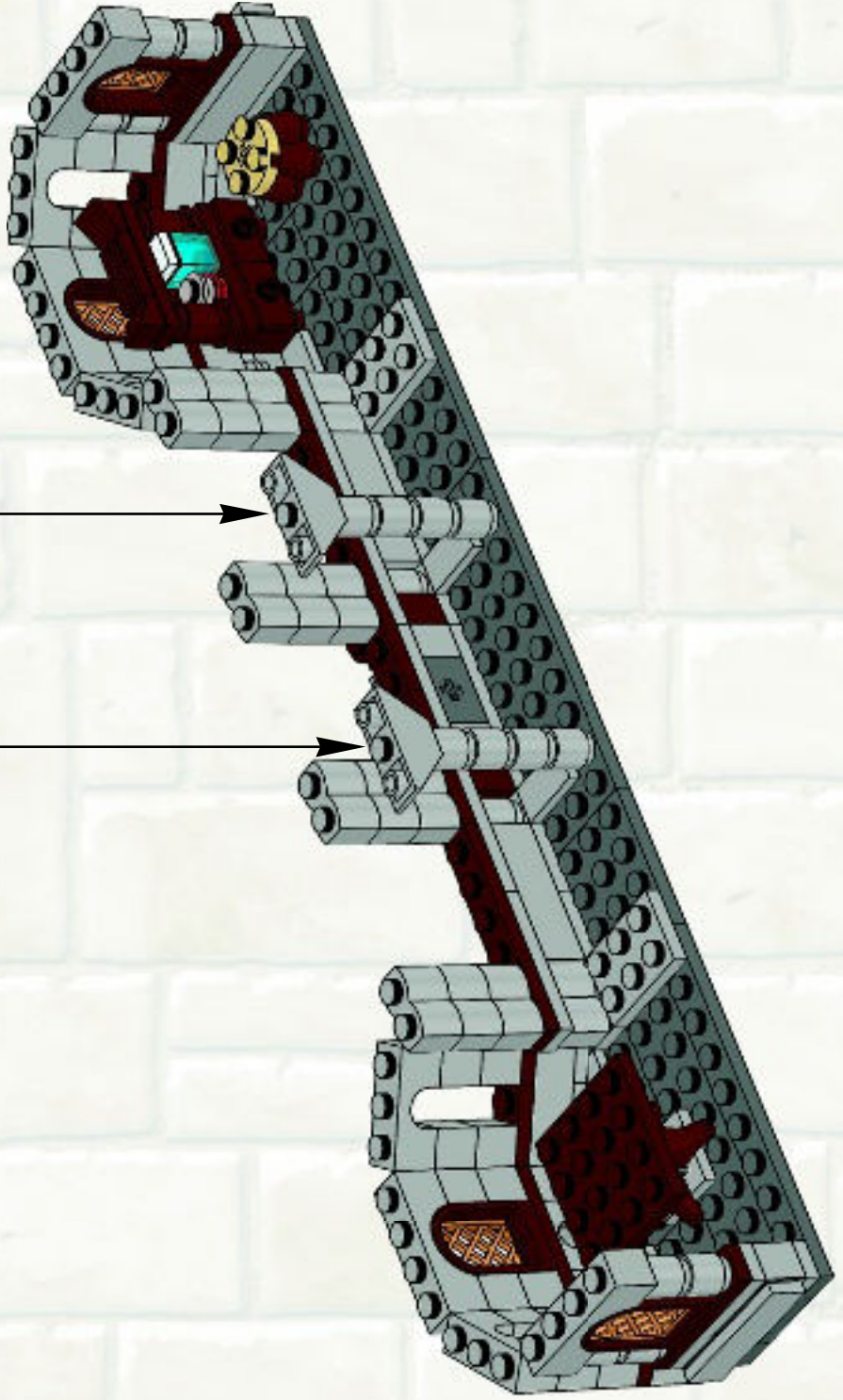

22

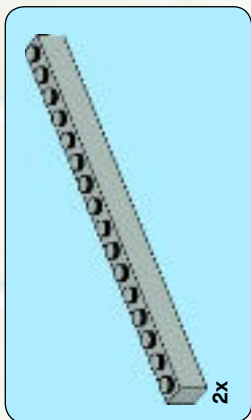
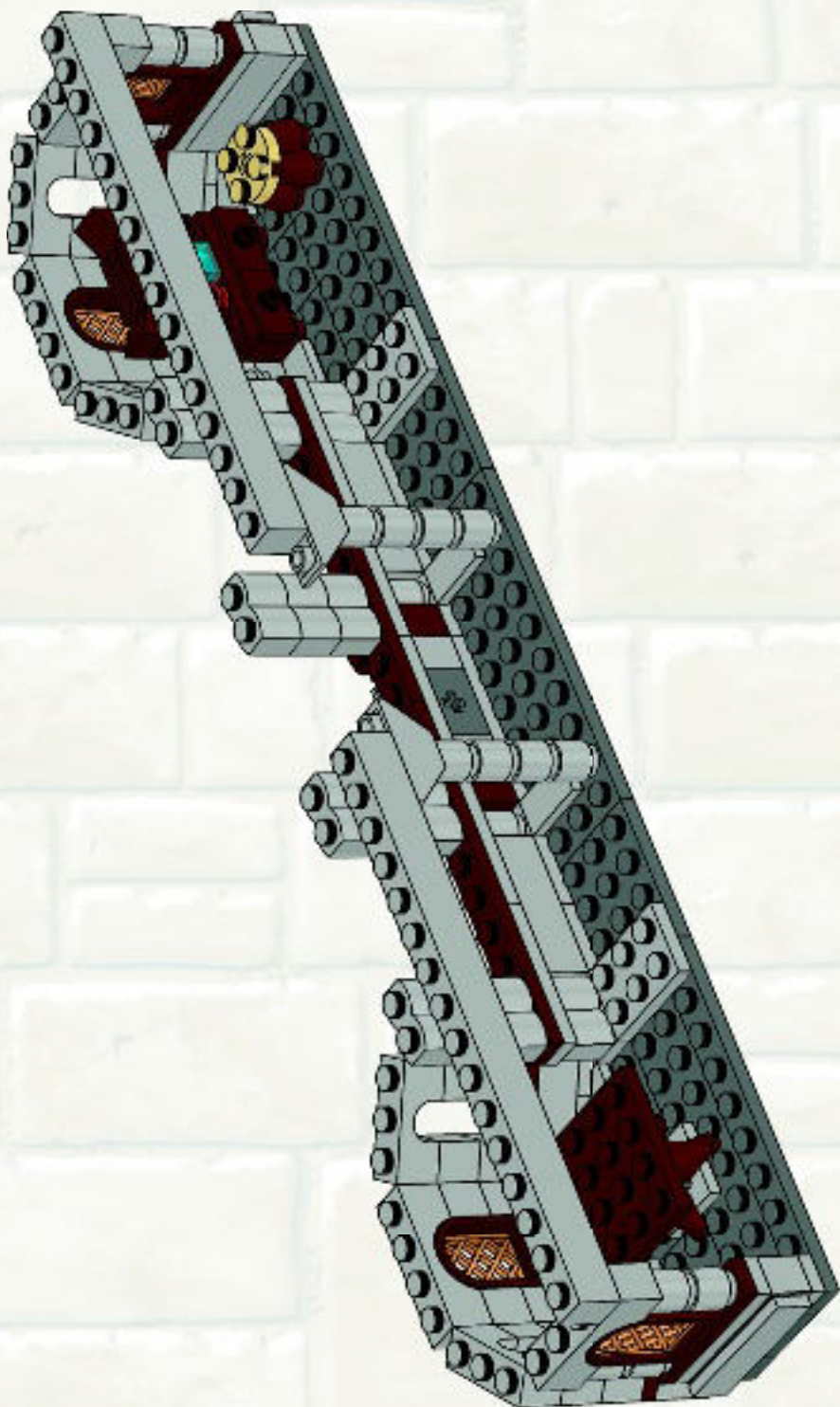

23

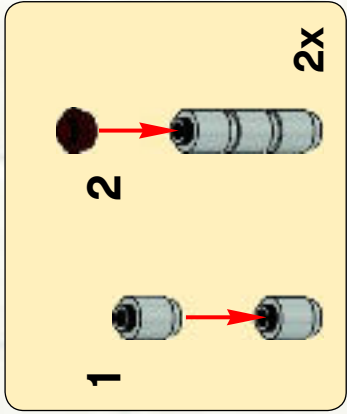
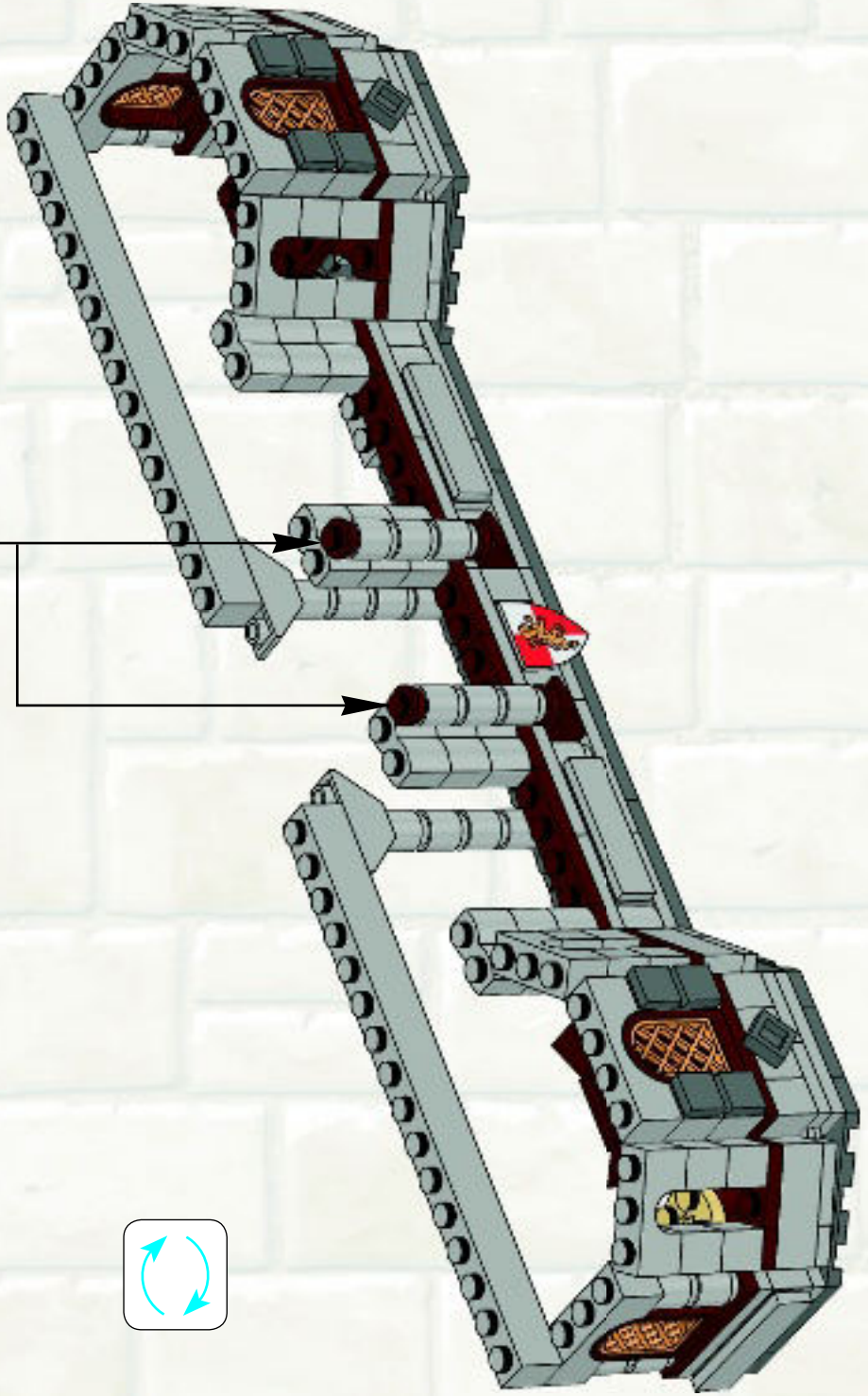

6x

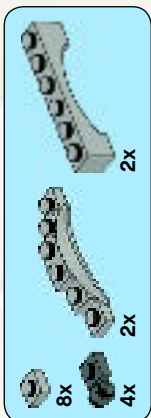
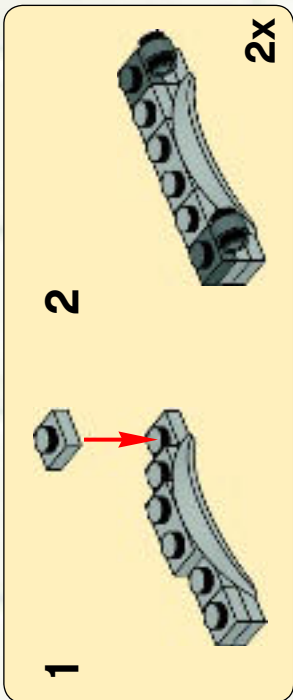
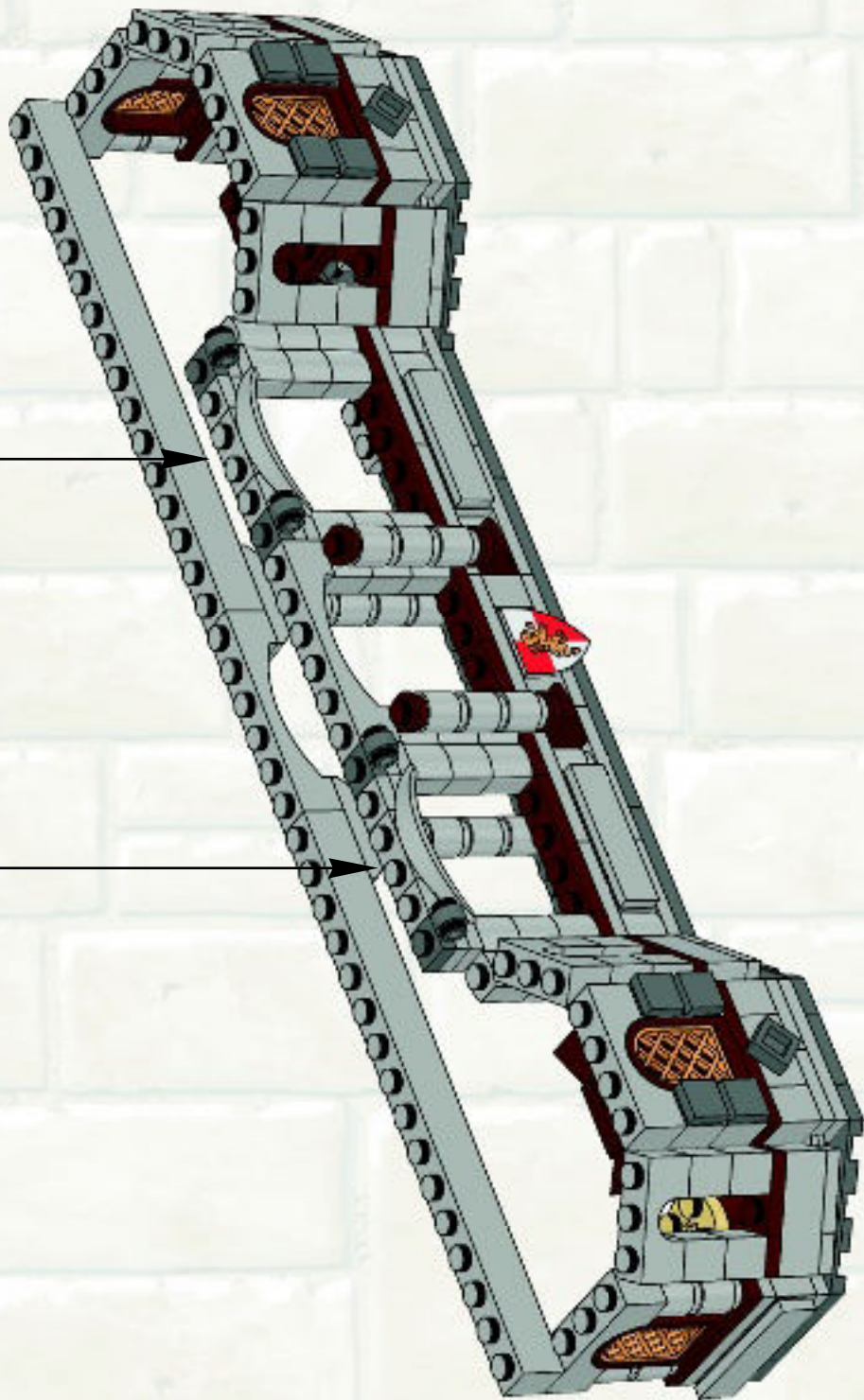

2x

24



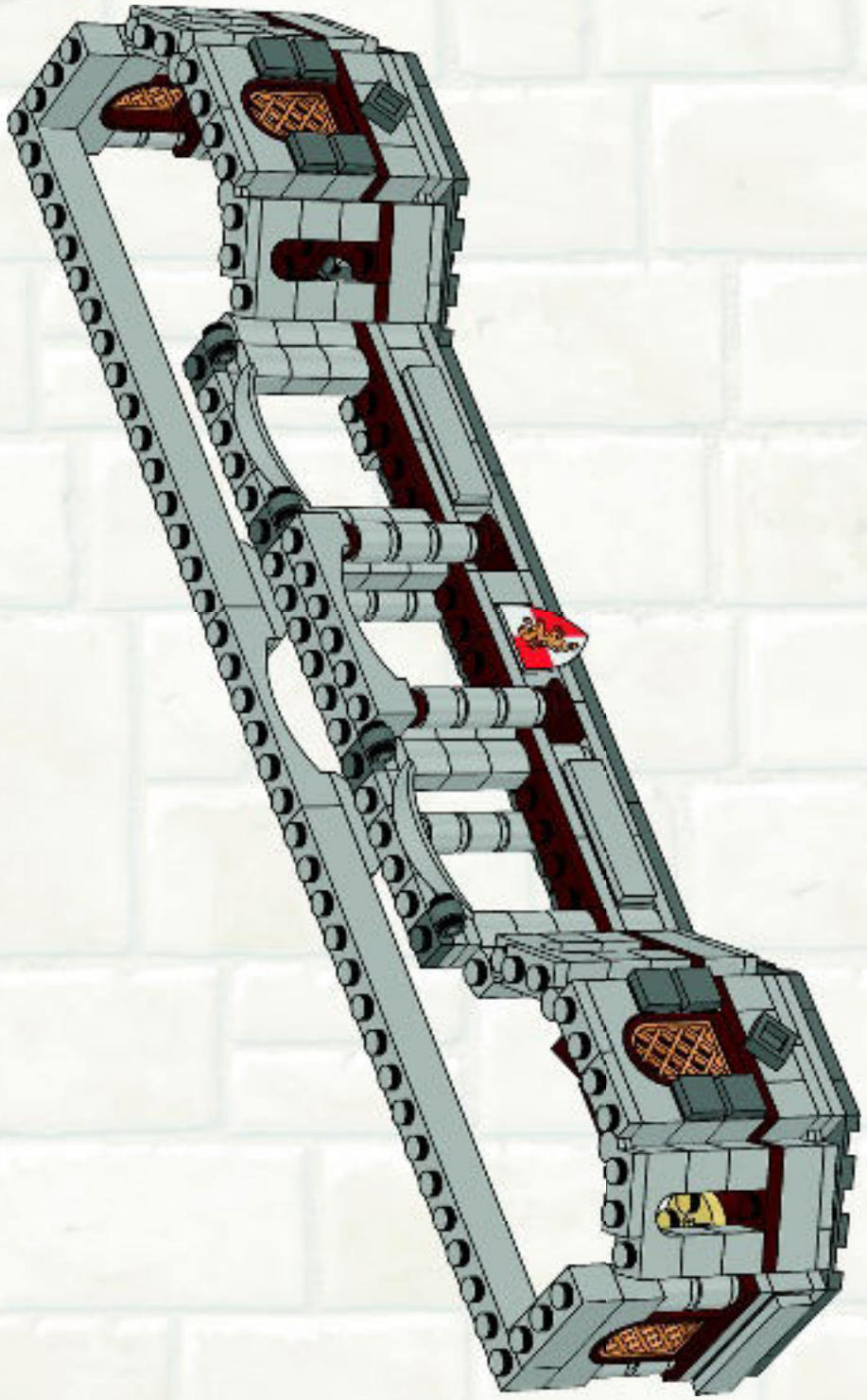

25



2x  4x  1x 

26

2x  4x 

27

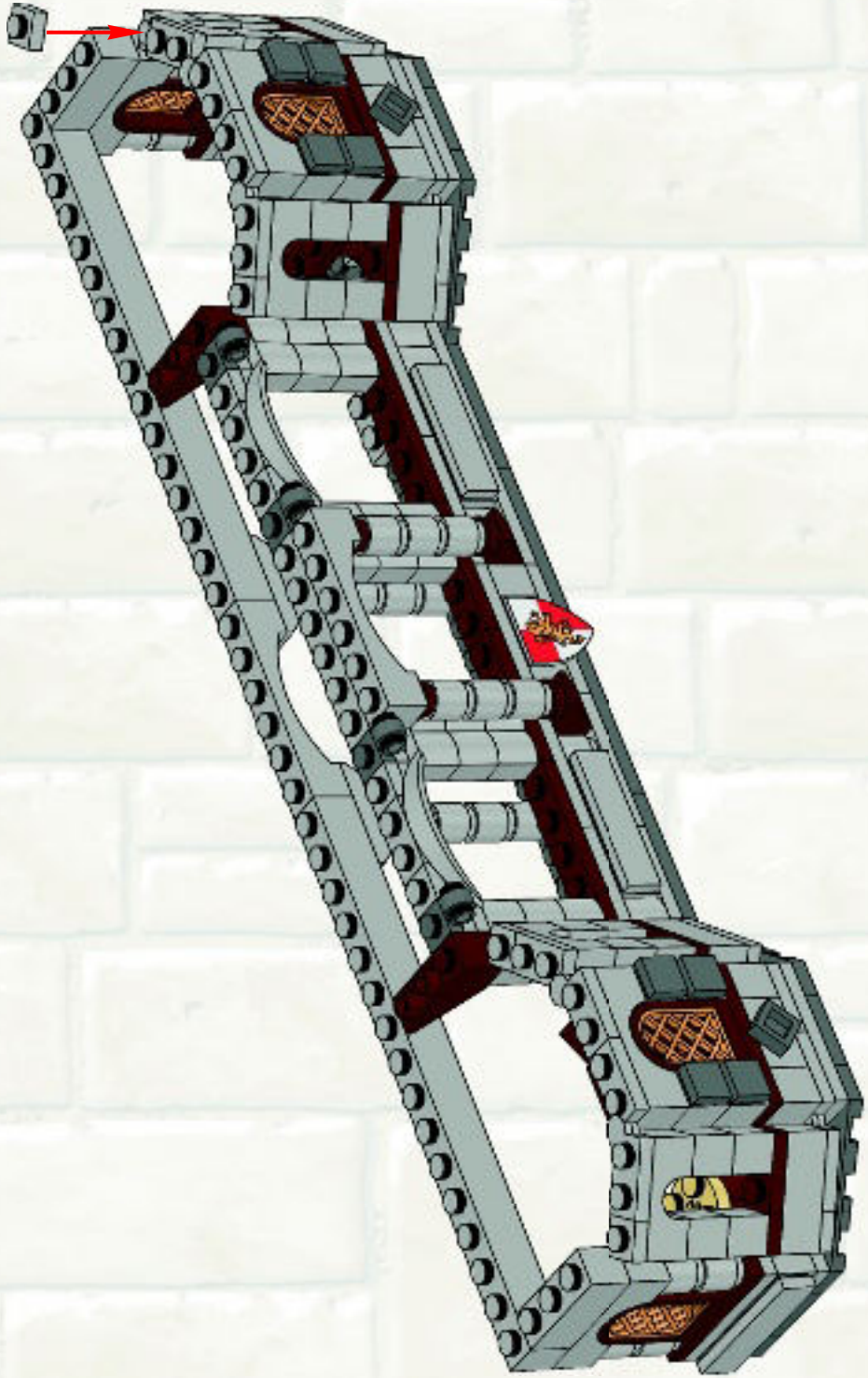



2x
12x

28

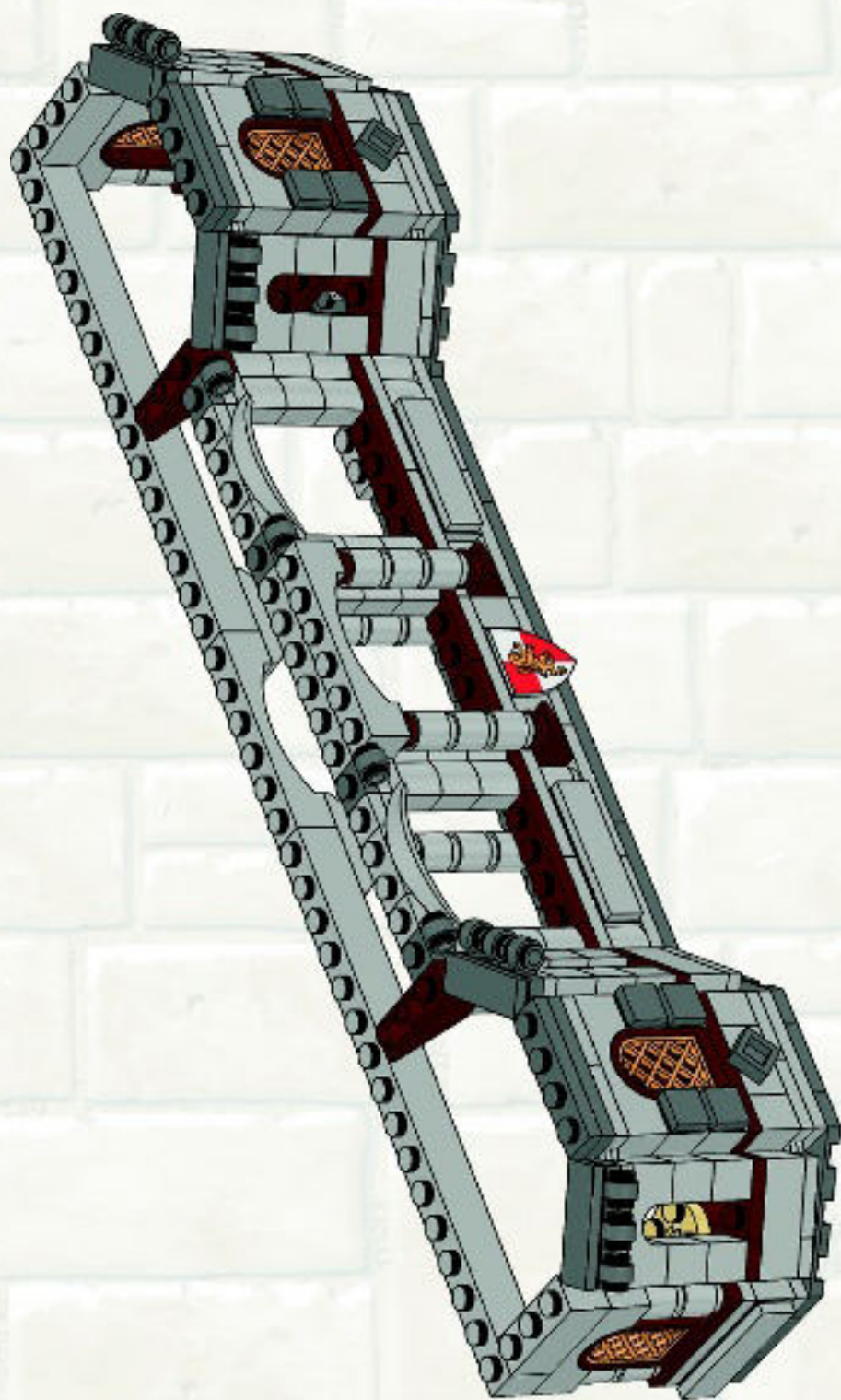

4x



2x



29

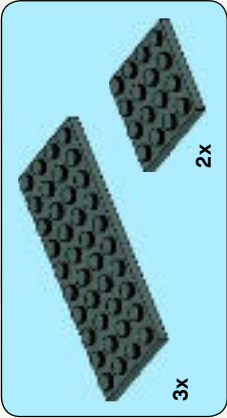

30

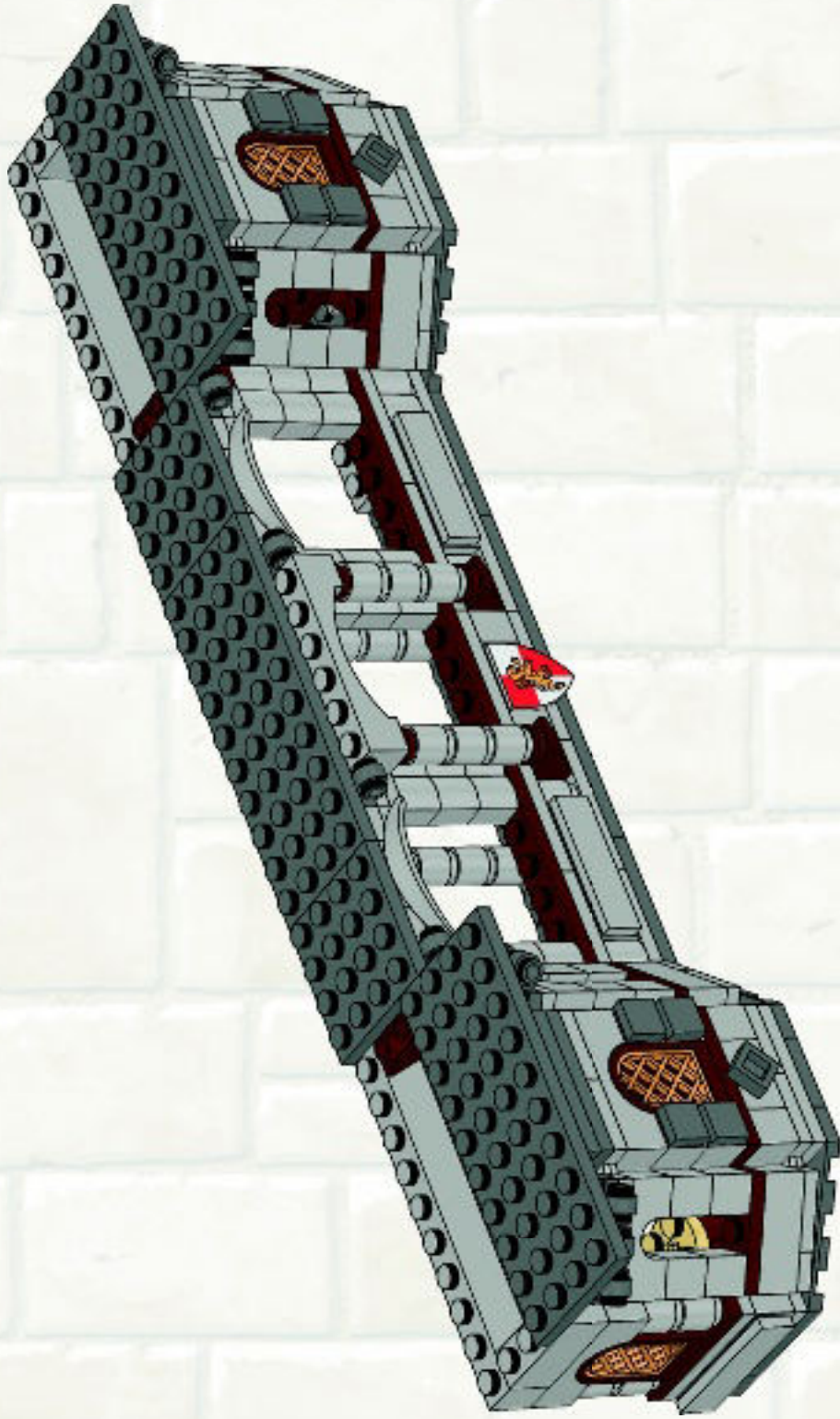

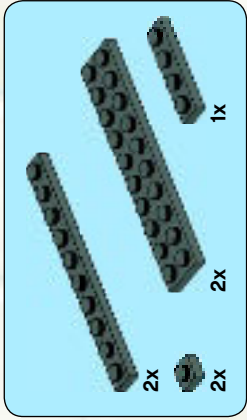

31

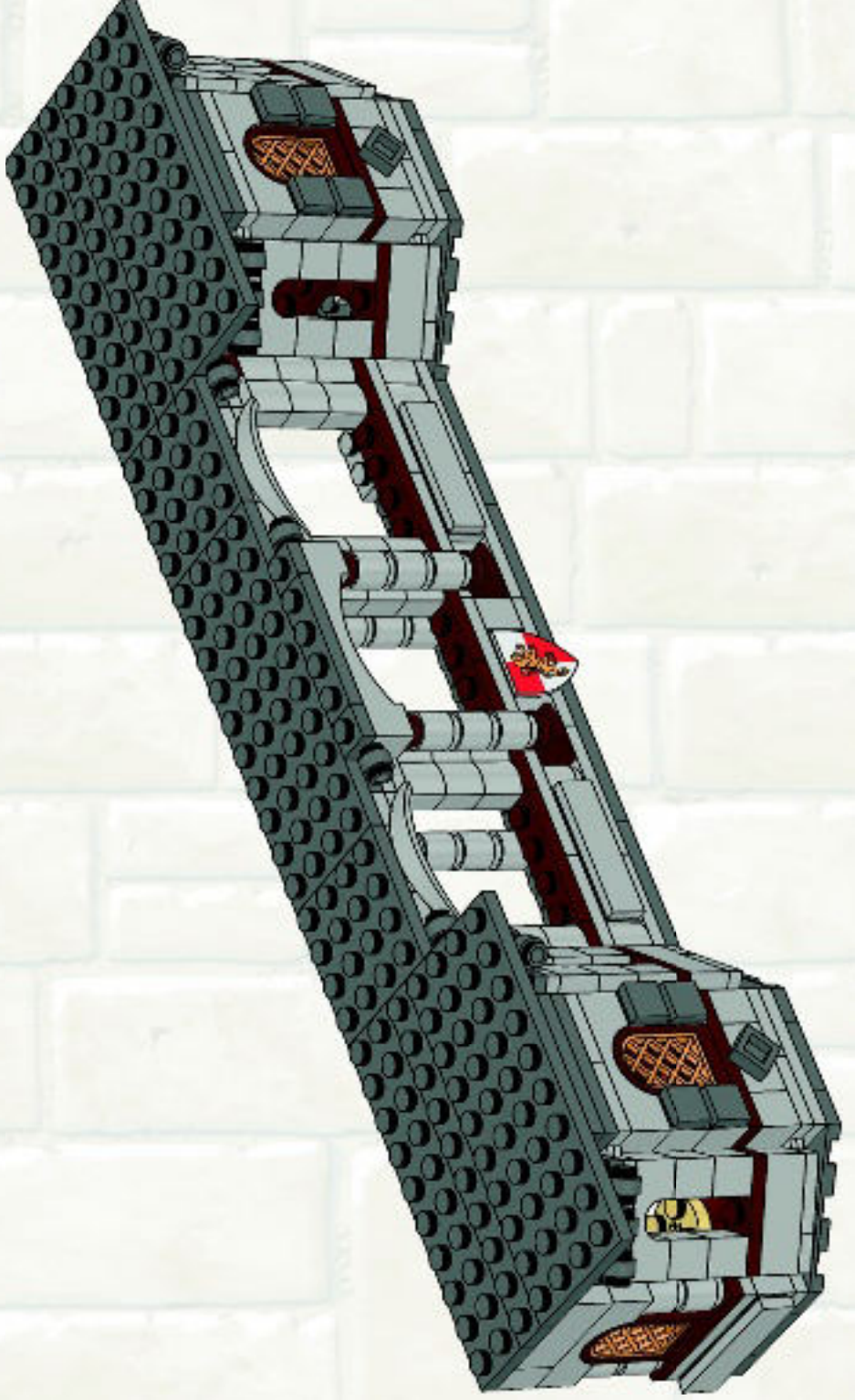

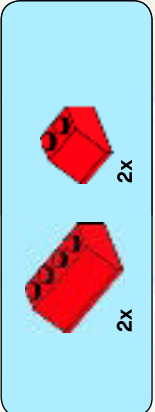
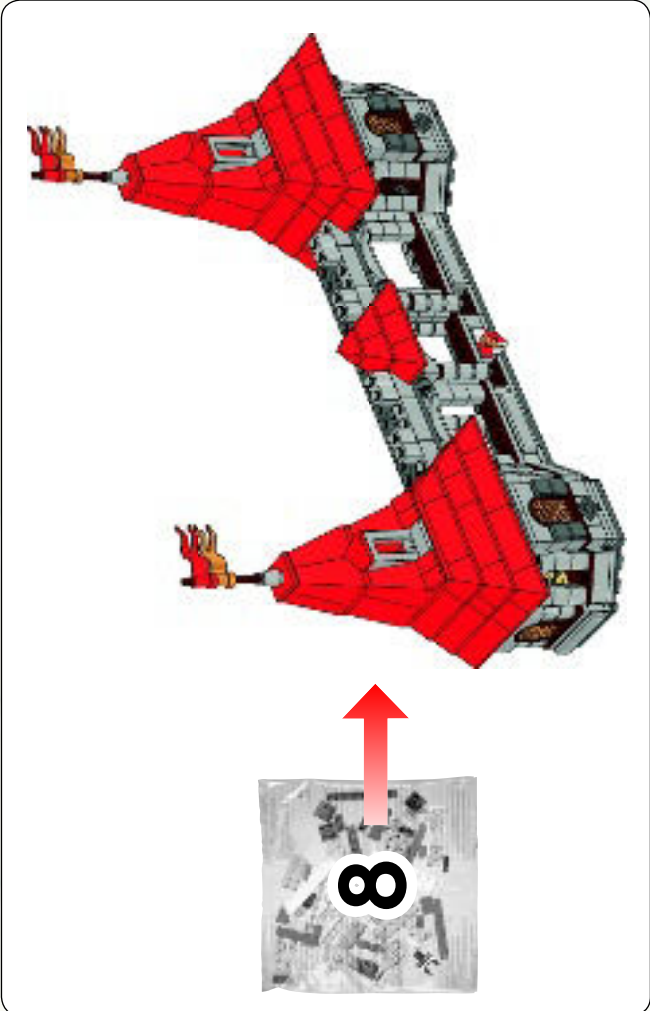
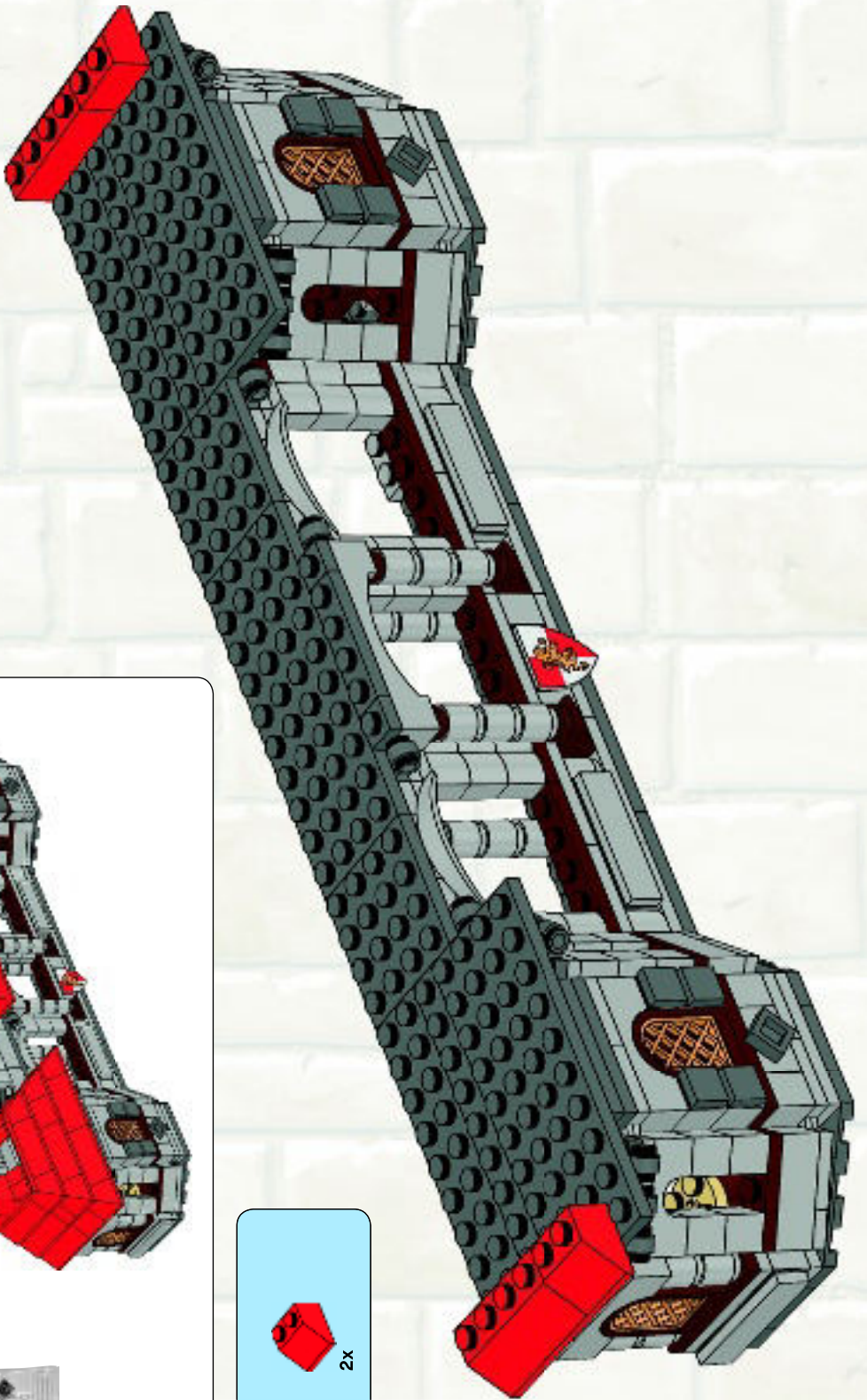

32



33

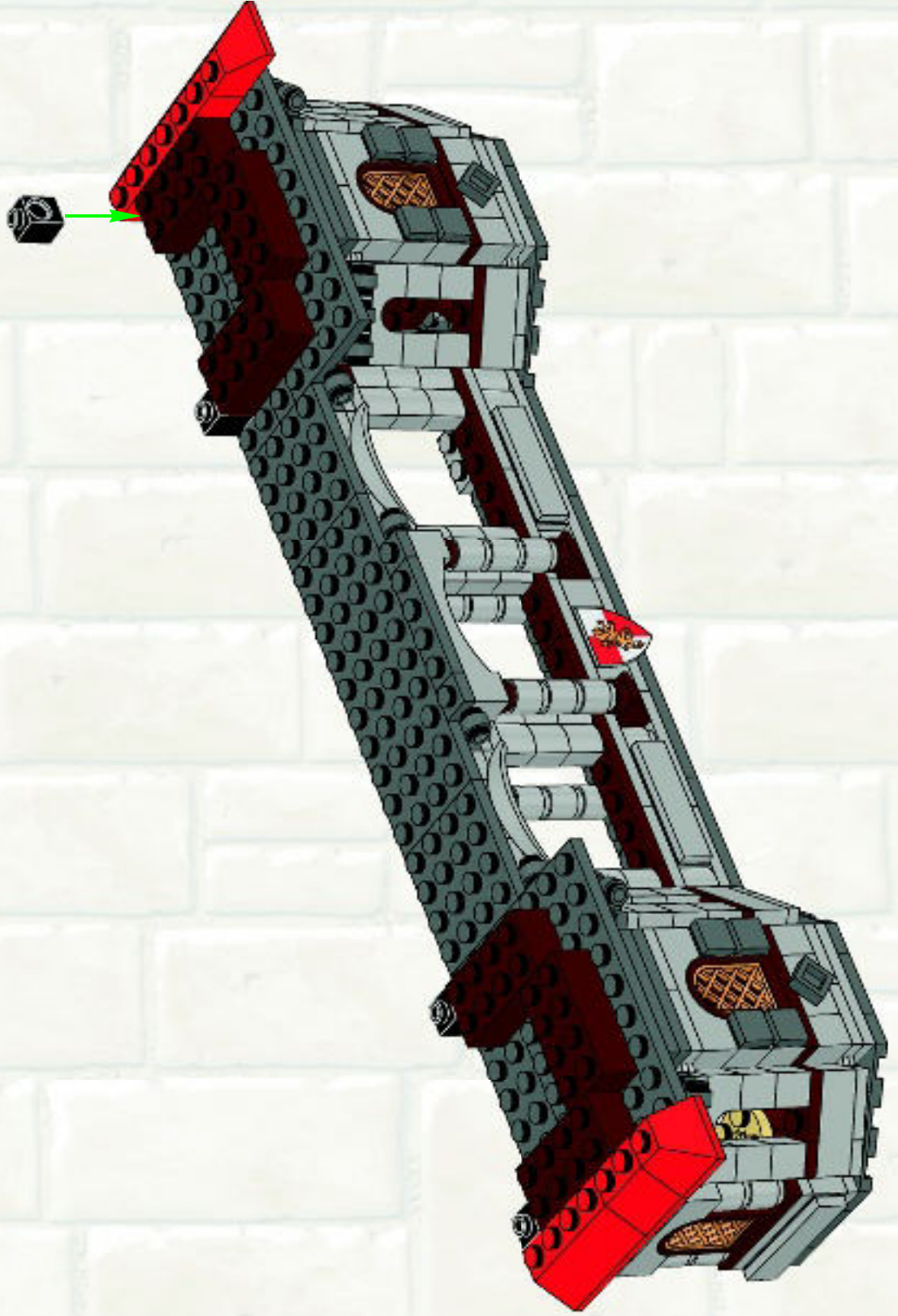

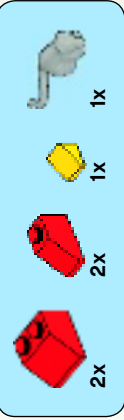

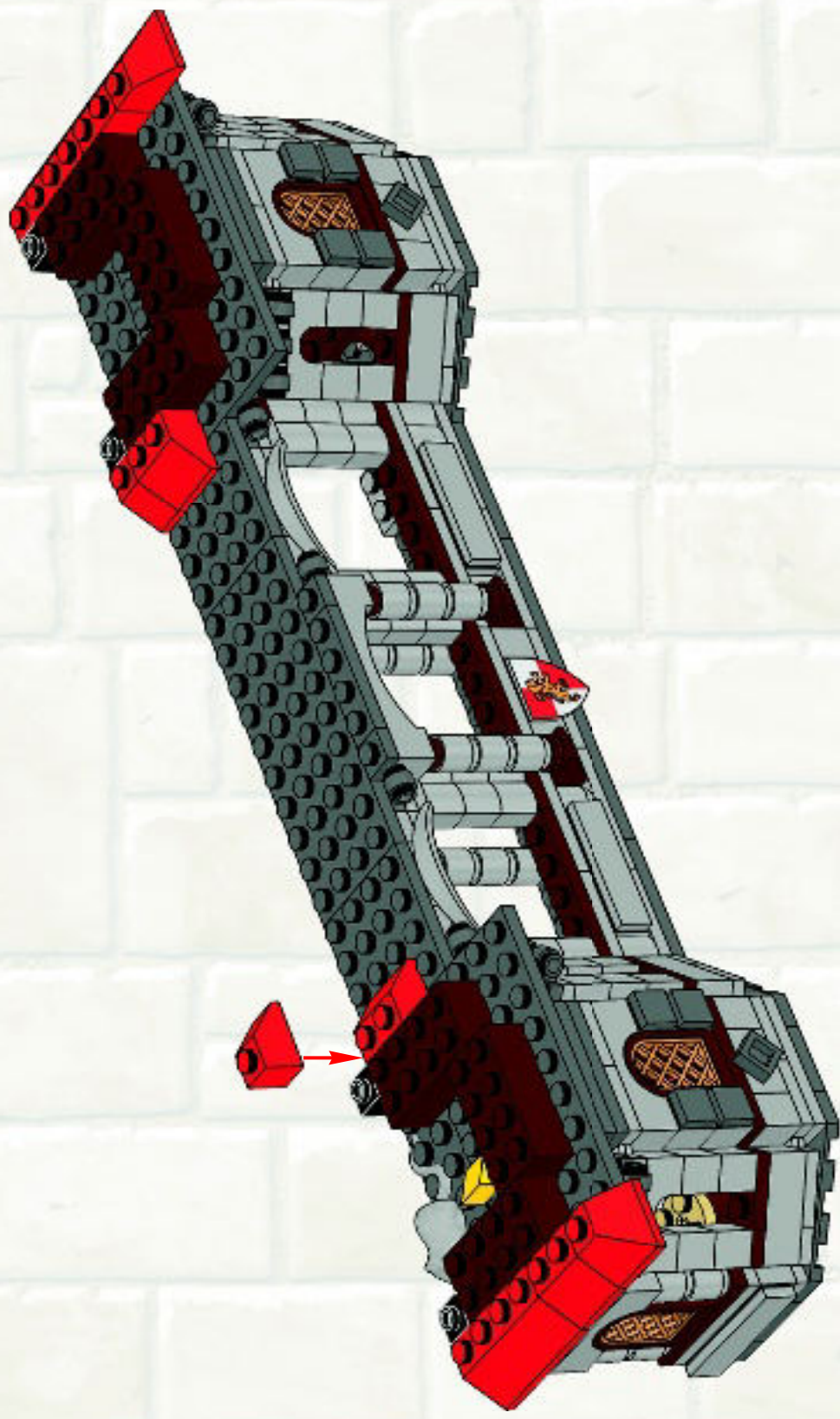

34











2x  1x  1x 

35



4x  1x  4x 



36

 2x
 6x
 4x

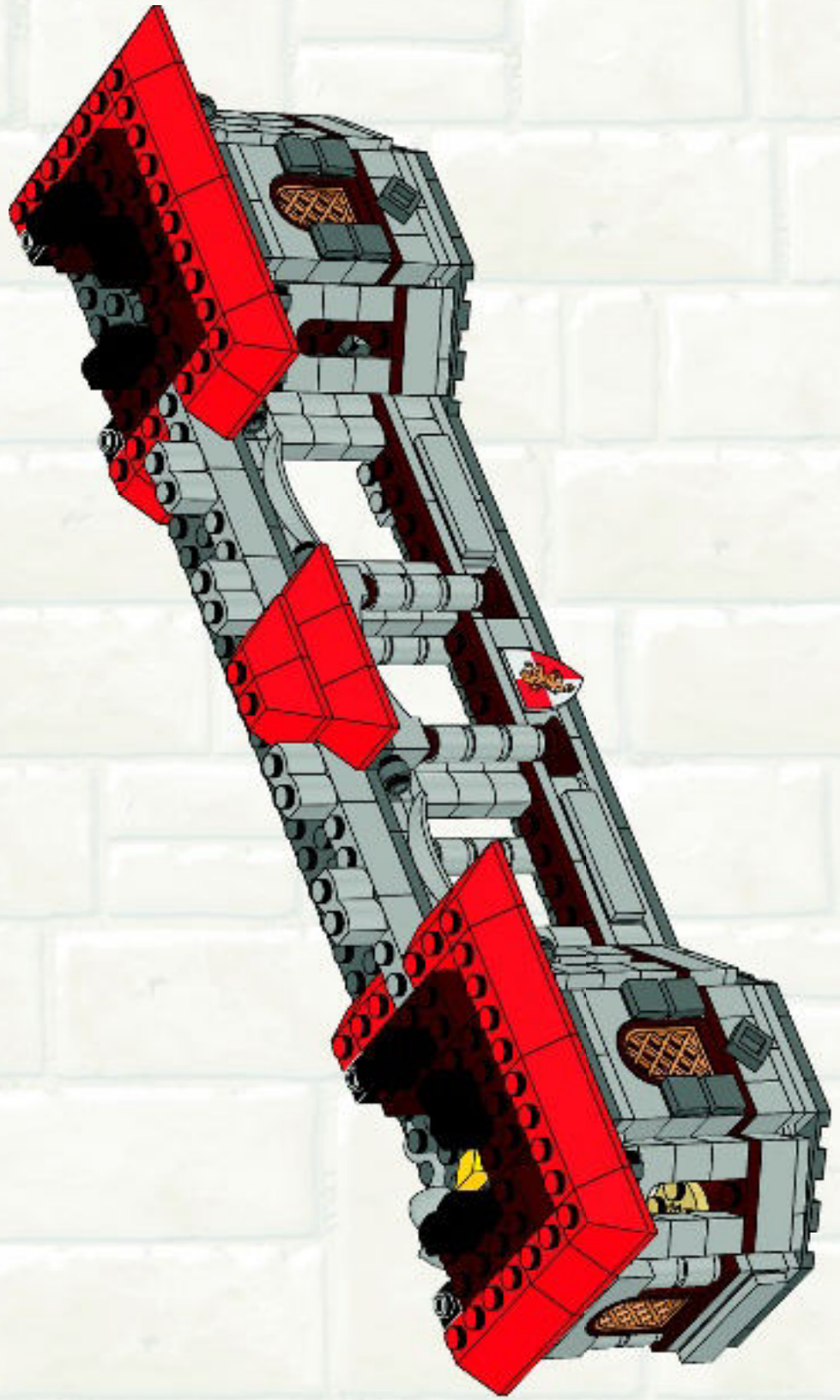
37

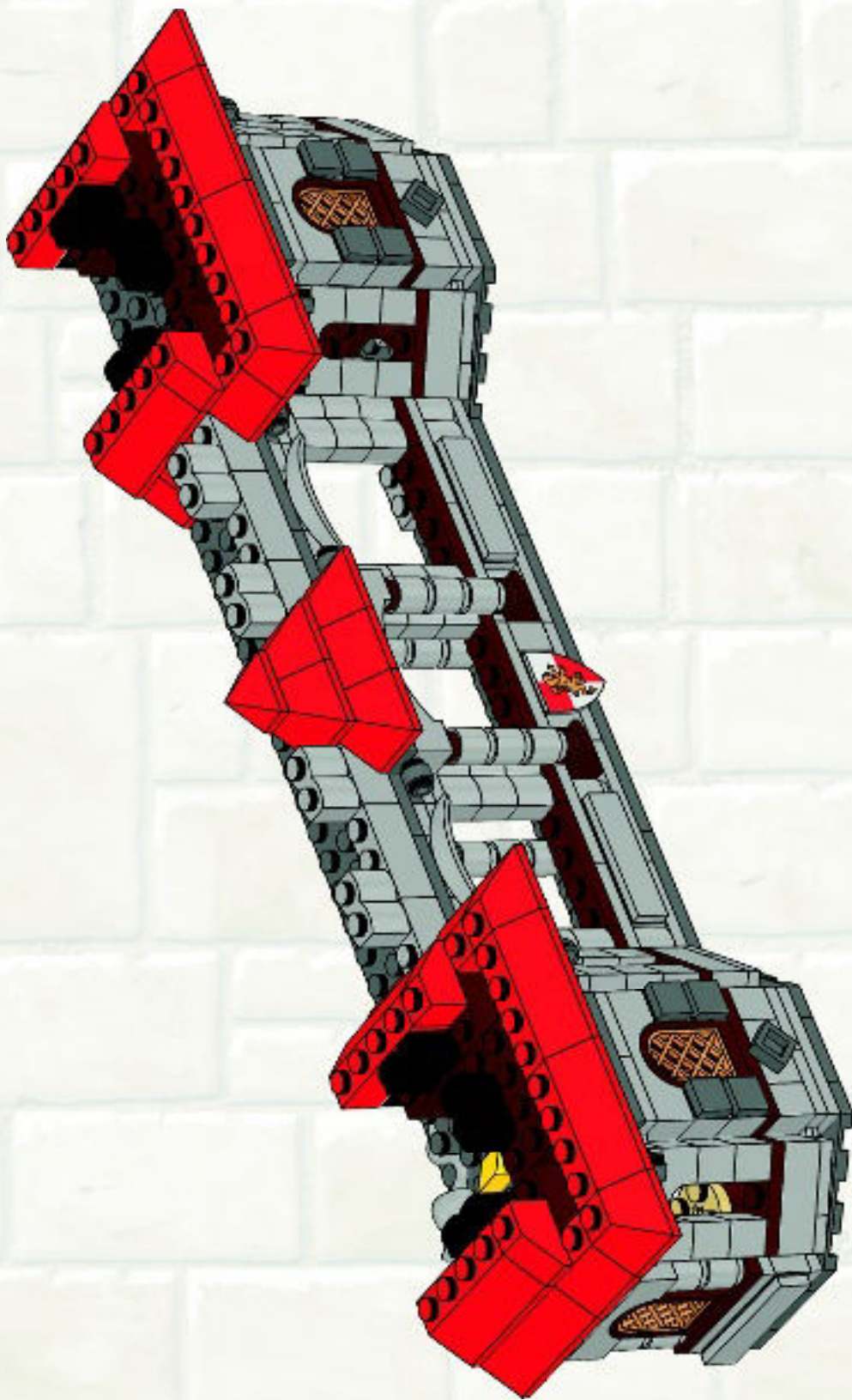



4x  4x  1x 

38

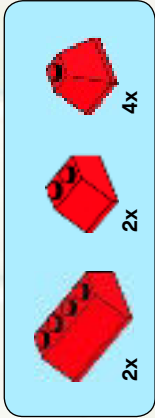

39

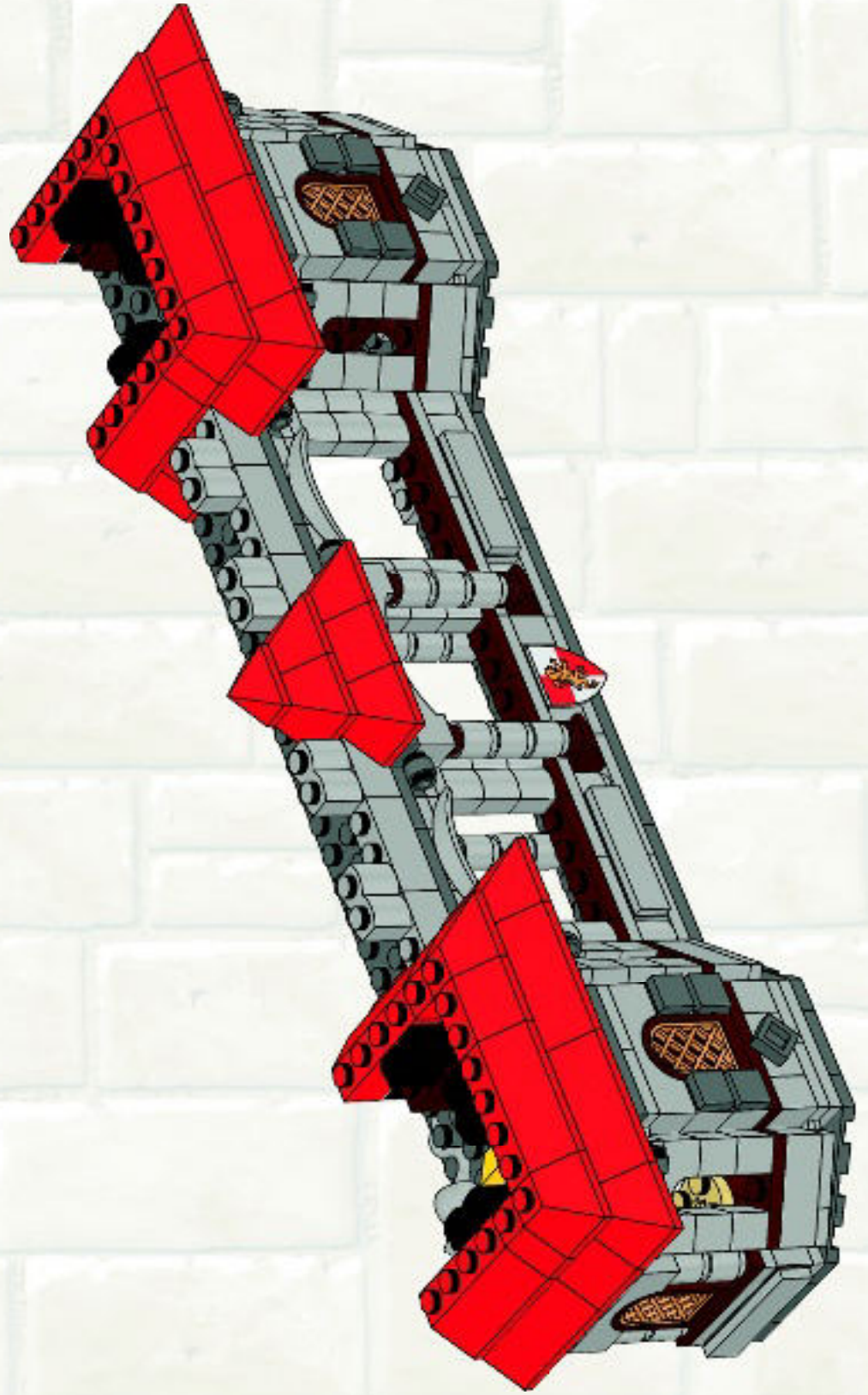

6x



4x



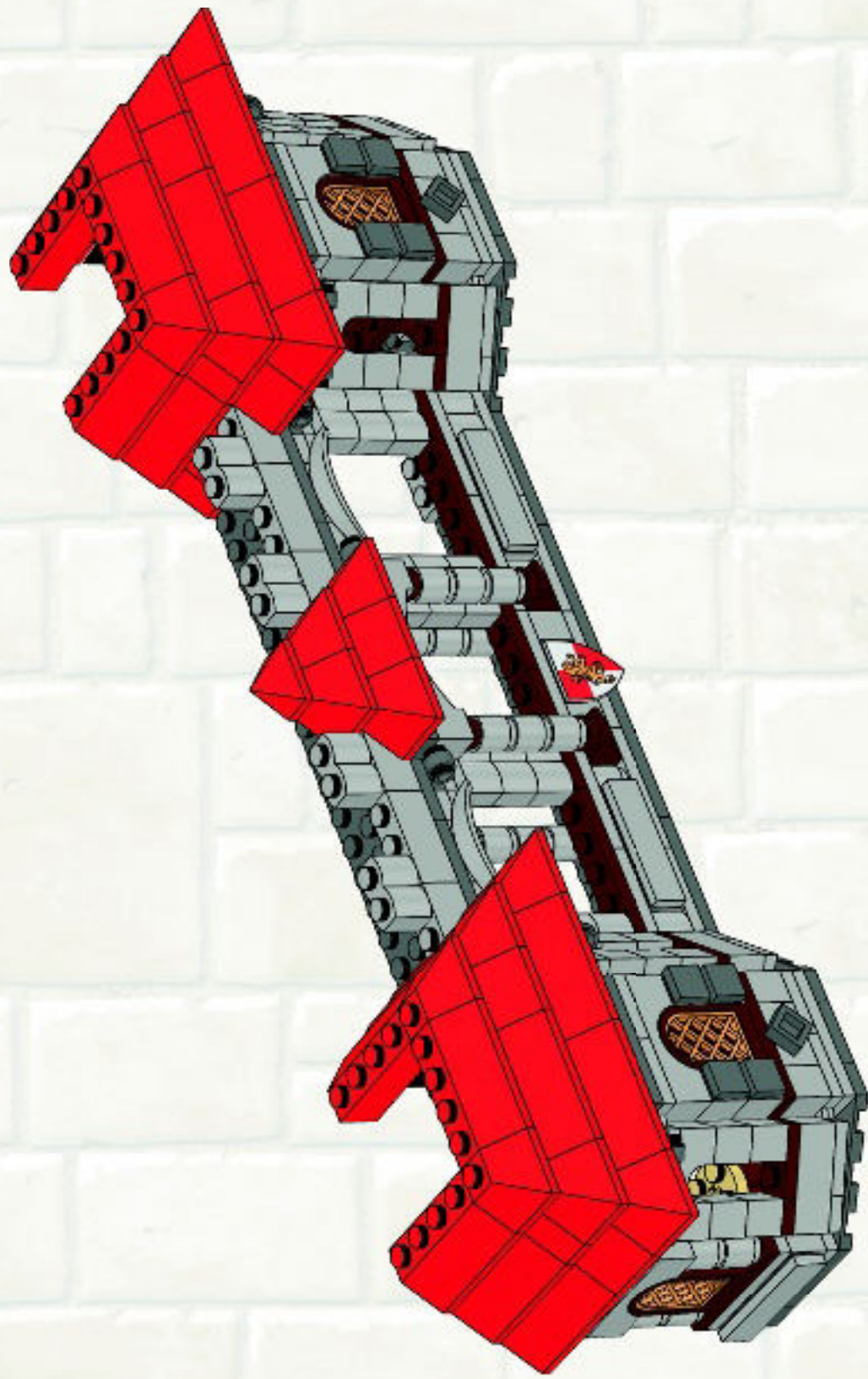

40

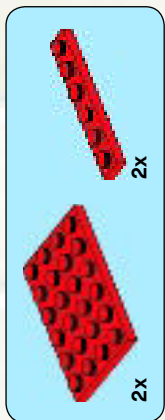
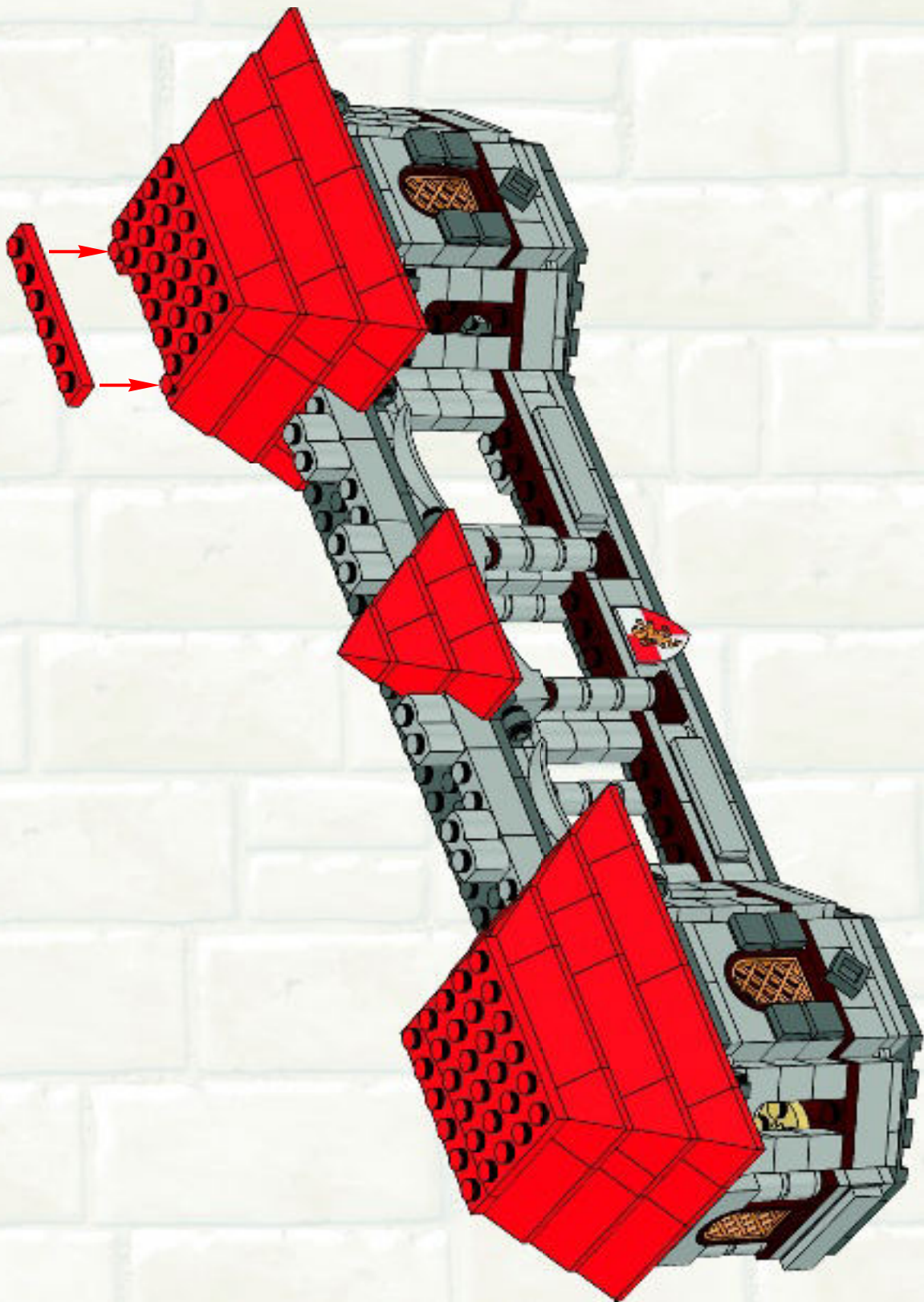



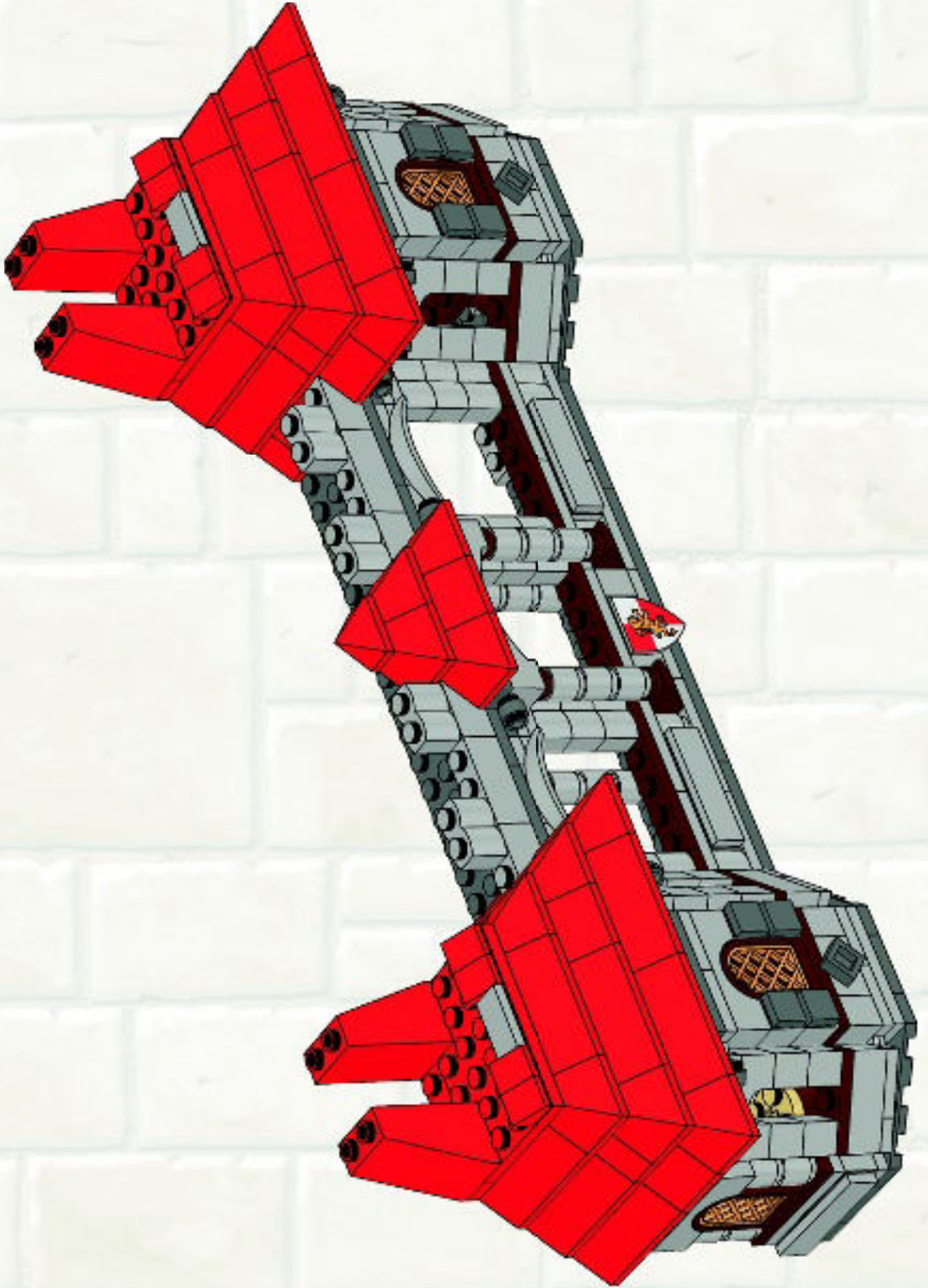

41



4x 

8x 

2x 

42

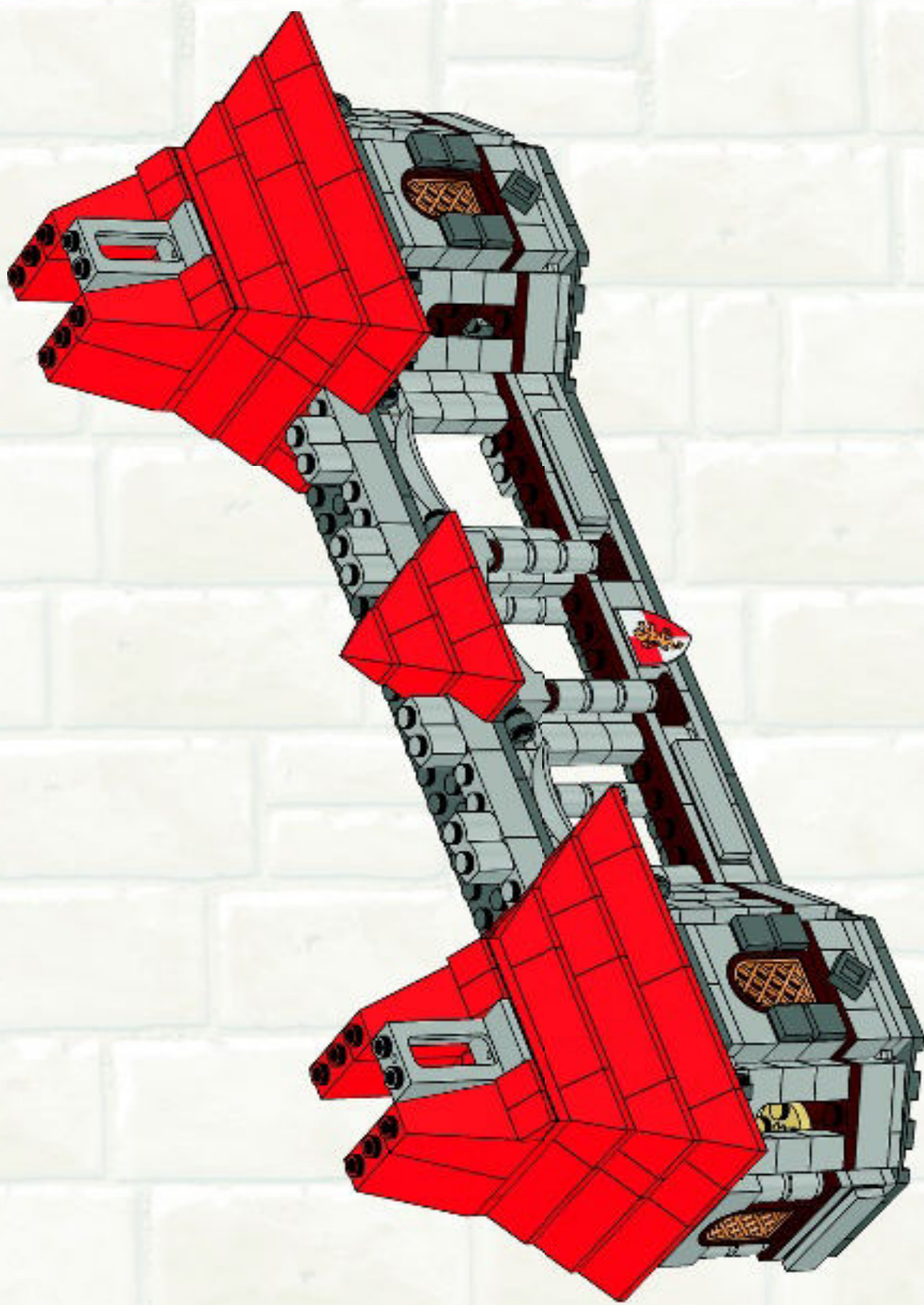



4x

2x

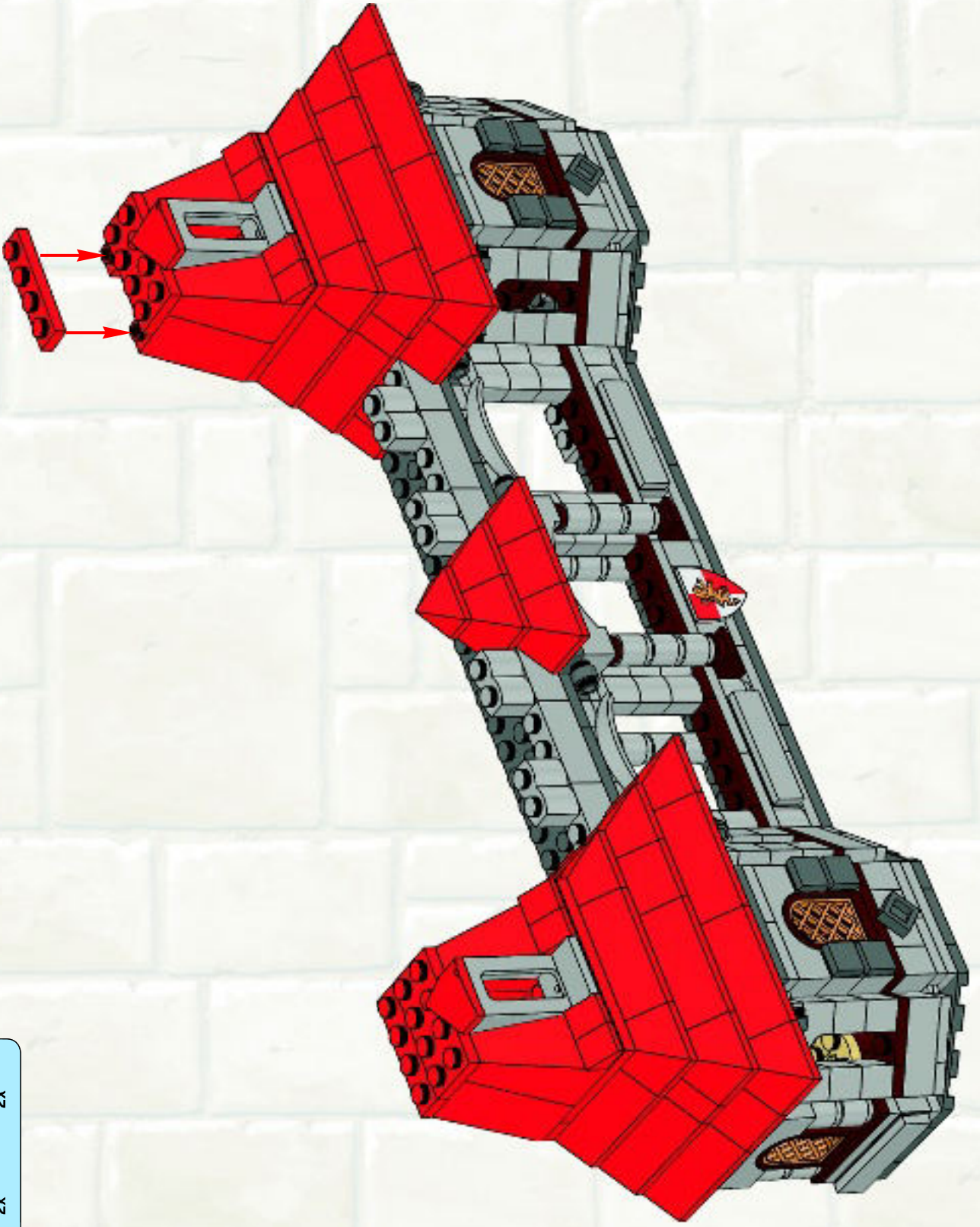
43



-  2x
-  2x
-  2x

44

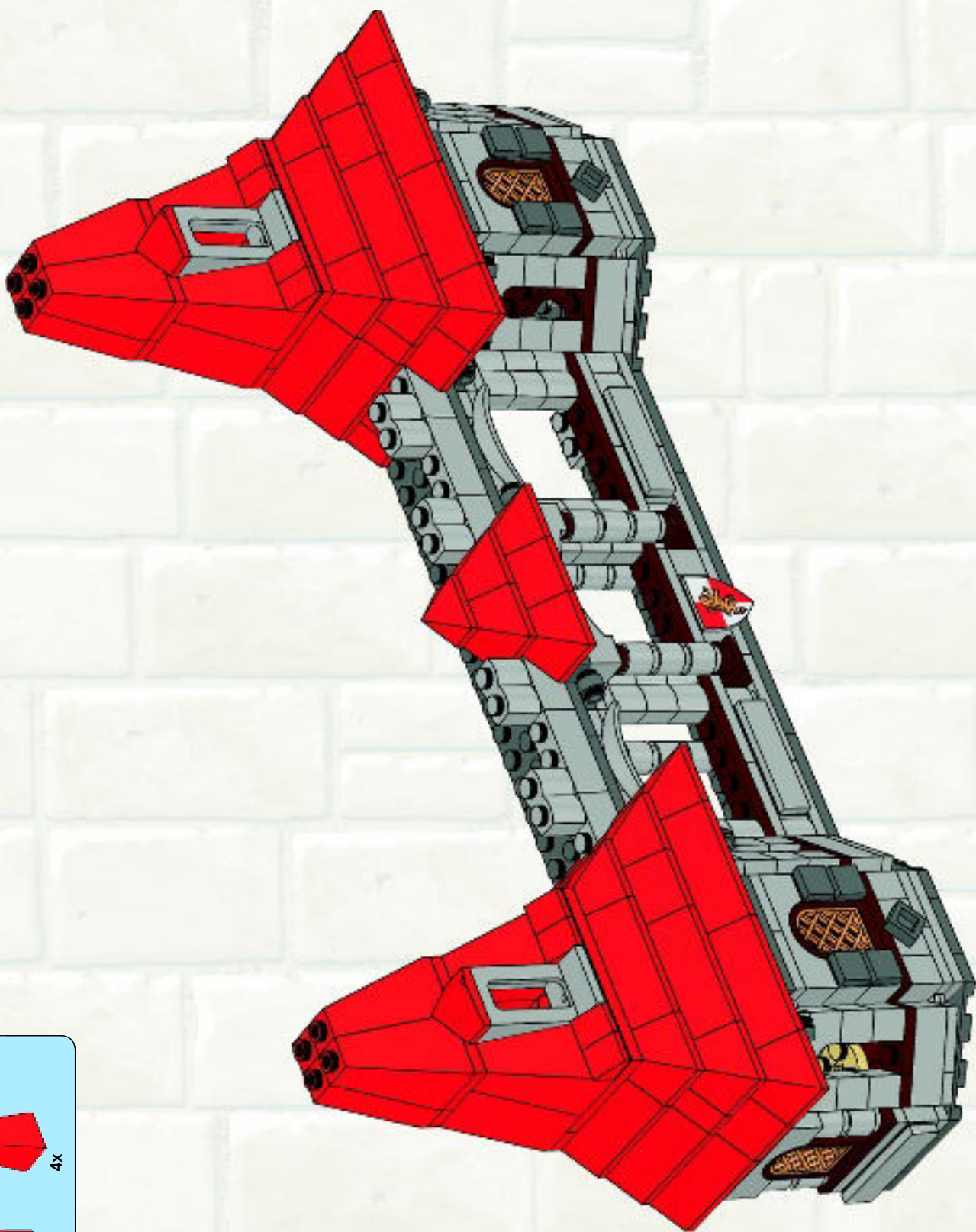

4x

4x

45

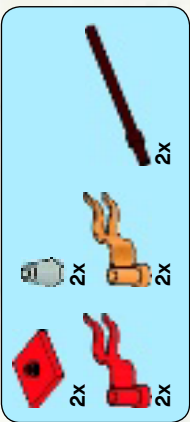

46

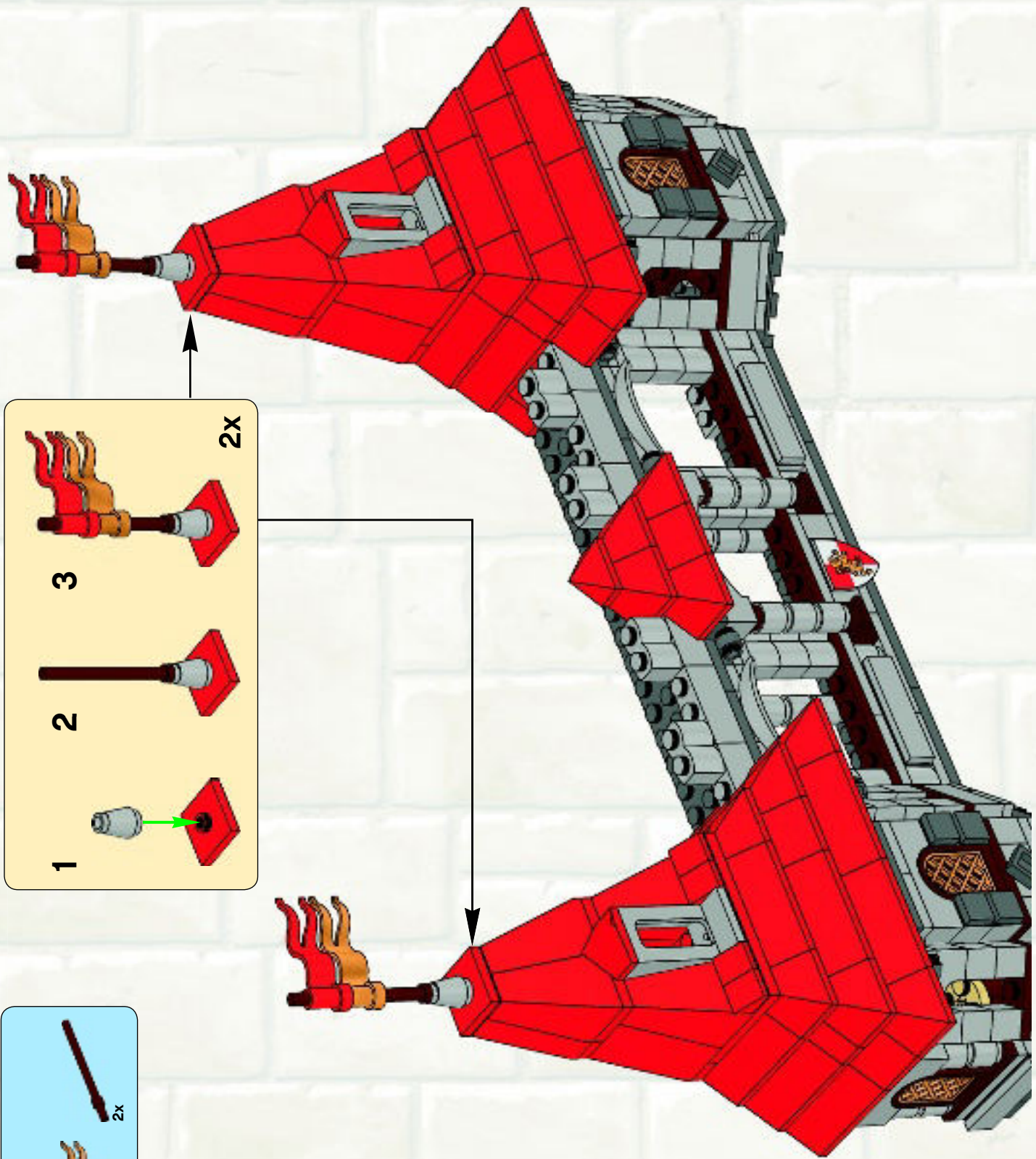
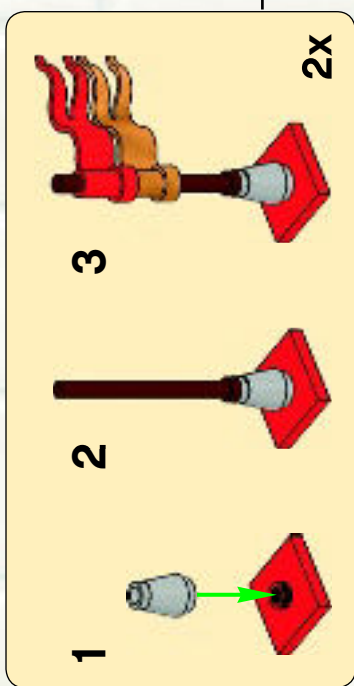





4x 4113261
 1x 300401
 1x 4111971
 4x 446001
 2x 245301
 6x 302301
 1x 302201
 2x 362301
 2x 366601
 2x 303201
 4x 4179870
 1x 307001
 2x 306901
 1x 4611700
 1x 04121830
 3x 4119227

2x 4523403
 2x 4140583
 2x 403201
 2x 4611446
 2x 4118793
 1x 4114084
 8x 4114026
 2x 4185177
 1x 4630045
 1x 4161734
 1x 4140562
 2x 4212410
 2x 4143832
 1x 4529234
 12x 4504379
 1x 4195004
 2x 4501534
 2x 4258056

6x 4121934
 2x 4515371
 6x 4162628
 20x 4163087
 11x 303921
 4x 4588467
 8x 4588468
 1x 4656147
 18x 303721
 4x 4180544
 2x 302321
 2x 4581308
 2x 371021
 2x 302021
 2x 366621
 3x 306921
 2x 4140585

1x 4585146
 2x 4523404
 5x 449521
 1x 4623373
 2x 4586497
 1x 4586509
 1x 4656114
 1x 4623967
 1x 4540552
 2x 4114585
 2x 303221
 1x 4587595
 1x 4504381
 1x 4261572
 1x 4225875
 1x 4259916
 1x 4651443
 1x 4586453
 1x 4584727

1x 4552666
 1x 4570043
 1x 4549621
 2x 4566308
 4x 300526
 5x 300426
 1x 4650900
 1x 473326
 8x 654126
 4x 446026
 4x 4189064
 2x 303926
 1x 302326
 2x 362326
 2x 4535739
 1x 614126
 2x 3004626
 1x 4586383
 1x 4568933
 1x 4586502

1x 384926
 1x 4656119
 2x 4636201
 2x 4188953
 2x 303226
 1x 4656125
 1x 4587388
 1x 4124096
 4x 4121715
 4x 242328
 4x 4651215
 4x 302028
 2x 4277361
 2x 4507311



- 5x 383228
- 1x 4157270
- 4x 4624184
- 4x 4616027
- 10x 3000841
- 1x 4656075
- 1x 4656100
- 1x 3005741
- 1x 4119350
- 10x 3000844
- 2x 4620380
- 14x 4620991
- 1x 4528604
- 2x 4578032
- 1x 4633881
- 1x 4542890
- 1x 4626884
- 2x 4583752
- 20x 4521915
- 2x 4245570
- 4x 4504375

- 1x 4266666
- 4x 4255624
- 2x 4583837
- 1x 4587127
- 1x 4590759
- 20x 4539090
- 1x 4586382
- 2x 4211149
- 5x 4211210
- 2x 4211200
- 2x 4211220
- 8x 4211201
- 20x 4225469
- 3x 4211180
- 2x 4215496
- 6x 4529242
- 61x 4211183
- 4x 4520612
- 22x 4504376

- 12x 4629736
- 1x 4211202
- 1x 4508616
- 4x 4211205
- 10x 4544167
- 12x 4221744
- 23x 4211150
- 7x 4565394
- 2x 4211257
- 1x 4216695
- 1x 4211189
- 25x 4211190
- 4x 4211186
- 8x 4221590
- 3x 4243838
- 4x 4216945
- 4x 4223683

- 6x 4211222
- 1x 4626196
- 2x 4211195
- 2x 4211197
- 10x 4219726
- 1x 4211151
- 1x 4224243
- 4x 4579690
- 12x 4216581
- 3x 4211159
- 8x 4542131
- 2x 4561915
- 12x 4623429
- 1x 4211300
- 1x 4641020
- 6x 4262974
- 2x 4538724
- 1x 4270443
- 1x 4598334

- 4x 4597977
- 1x 4506003
- 1x 4624905
- 1x 4211211
- 2x 4211207
- 3x 4223729
- 1x 4225715
- 2x 4222627
- 30x 4558953
- 44x 4211389
- 8x 4211349
- 64x 4211428
- 15x 4211394
- 2x 4211366



2x
4225532



23x
4550325



6x
4211383



4x
4211636



48x
4211412



2x
4529241



24x
4651063



2x
4211440



20x
4521921



4x
4211614



6x
4211437



6x
4211410



6x
4211436



2x
4251563



4x
4645397



7x
4211435



2x
4221600

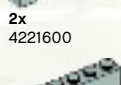

4x
4618874

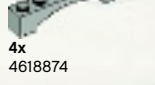

1x
4221589



32x
4211399



4x
4211398



1x
4565393



2x
4211396



20x
4211445



12x
4211414



4x
4211356



8x
4219256



2x
4233652



2x
4492335



1x
4586384



1x
4586504



4x
4586308



3x
4656132



1x
4586292



1x
4512743



5x
4532589



2x
4211469



2x
4211881



6x
4211103



4x
4213574



4x
4210636



1x
4210935



40x
4211090



1x
4529240



4x
4624186



14x
4211111



12x
4504378



20x
4210848



16x
4632574



12x
4210633



1x
4220973



4x
4210719



6x
4211063



8x
4211001



6x
4211065



4x
4243831



8x
4257526



8x
4210678



12x
4210728



1x
4211052



10x
4568734



10x
4211053



3x
4560184



4x
4271344



2x
4211042



1x
4271950



4x
4221591



1x
4211066



4x
4210795



4x
4216479



1x
4505990



1x
4584762



44x
4523159



8x
4541895



4x
4504649



1x
4656153



1x
4100457



6x
4249039



1x
4506721



2x
4506011



1x
4287800



6x
4519970



7x
4566688



31x
4536989



1x
4536677



10x
4538950



1x
4632767



1x
4540850



2x
4569473



1x
4622738



1x
4612177



1x
4656388



1x
4633691



1x
4611880



1x
4611879



2x
4611883



1x
4611884



2x
4613958



1x
4617242



1x
4629841



Customer Service
Kundenservice
Service Consommateurs
Servicio Al Consumidor

www.lego.com/service or dial

00800 5346 5555 :     

1-800-422-5346 :  

LEGO club™

FREE! GRATIS! GRATUIT!



www.LEGOclub.com



LEGO® Club Magazine



LEGO® Club Email

SIGN UP ONLINE!

www.LEGOclub.com

VISIT THE WORLD'S
BIGGEST LEGO® SHOP!

www.LEGOshop.com



GO TO

www.LEGOclub.com

00800 5346 5555*



1-866-534-6258 • 1-877-518-5346

US & Canada only

Canada seulement



* Freephone. Mobile charges may apply. * Numéro sans frais. Des frais peuvent s'appliquer avec les téléphones cellulaires. * Gebührenfrei, Kosten für Anrufe aus Mobilfunknetzen können abweichen. * Gratis telefoonnummer vanaf vaste lijn. * Det er et gratis nummer, når du ringer fra fasttelefon. * Det är gratis, när du ringer från en fast telefon. * Numéro sans frais. Des frais peuvent s'appliquer avec les téléphones portables.

WINNI!

Go to www.LEGOsurvey.com/product to fill out a survey for a chance to win a cool LEGO® Product. No purchase necessary. Open to all residents where not prohibited.



www.LEGO.com

www.LEGOsurvey.com/product

GEWINNE!

Nimm an der Umfrage auf www.LEGOsurvey.com/product teil und hab die Chance ein cooles LEGO® Produkt zu gewinnen! Die Teilnahme am Gewinnspiel führt zu keinerlei Kaufverpflichtungen, Teilnahme in allen nicht ausgesetzten Ländern möglich.

WINNI!

Ga naar www.LEGOsurvey.com/product, vul een enquêteformulier in en maak kans op een cool LEGO® product. Geen aankoopverplichting. Iedereen mag deelnemen, uitzonderend ingezetenden van landen waar een enquêteverbod geldt.

GAGNE!

Visite www.LEGOsurvey.com/product pour répondre à un questionnaire et avoir une chance de gagner un produit LEGO® très COOL !
Aucune obligation d'achat.
Ouvert à tous les résidents des pays autorisés.

当てよう!

www.LEGOsurvey.com/product にアクセスして、アンケートにご記入ください。当選者にはレゴ製品を差し上げます。
お買い上げの必要はありません。
禁止されていない限り、すべての年齢にご利用いただけます。